

Nexans



Nexans Cabling Solutions
LAN Systems

Energy Efficient Datacentres

Next-generation solutions from Nexans



Data centre managers face common challenges - to keep information flowing reliably, to plan for future migration and to manage energy consumption.

Nexans can help meet these challenges with reliable infrastructure solutions which offer a migration path to 40G whilst delivering the maximum potential for energy efficiency.

With Environmental Monitoring and Access Control (EMAC) and LANsense Intelligent Infrastructure Management, Nexans offer complete infrastructure solutions for data centres.

Nexans Cabling Solutions

Alsebergsesteenweg 2, b3

B - 1501 Buizingen

Tel: +32 2 363 38 00 • info.ncs@nexans.com

www.nexans.com/LANsystems

Global expert in cables
and cabling systems

Table of content

Nexans	7
Symbols	8
LANsystems Introduction	9
LAN Cabling Systems	20
Copper	21
Category 5e	22
LANmark-5 Cable	23
LANmark-5 Snap-In connector	26
LANmark-5 Patch Panels	28
LANmark-5 Outlet 45x45	30
LANmark-5 UniBoot Patch Cords	32
Essential Cat 5e Cable	35
Essential Snap-In Connector	38
Essential-5 Keystone Connector	40
Essential Patch Panels	42
Essential Outlet Modules	44
Essential Cat 5e Patch Cords	46
Category 6 / 6A	48
LANmark-6 Cable	49
LANmark-6 Snap-In Connector	52
LANmark-6 UniBoot Patch Cords	54
LANmark-6 10G UniBoot Patch Cords	56
LANmark-6 10G Snap-In Connector	58
LANmark-6A Cable	61
LANmark-6A Connector	63
LANmark-6A Ultim UniBoot Patch Cords	66
Essential-6 Cable	69
Essential-6 Keystone Connector	71
Essential-6 Patch Panels	73
Essential-6 Outlet Modules	75
Essential-6 Patch Cords	77

Category 7 / 7A	80
LANmark-7 Cable	81
LANmark-7 GG45 Connector	83
GG45 8C PCB jack	85
LANmark-7 Patch Cords	87
LANmark-7 Splitter Cords	89
LANmark-7A Cable	91
LANmark-7A GG45 Connector	92
LANmark-7A Patch Cord	95
Modular Patch Panels	97
Modular Patch Panels for Snap-In Connectors	98
Empty Patch Panels for Keystone Connectors	100
Modular Outlets	102
European Mounting Hardware for LANmark	103
UK Mounting Hardware for Essential	104
UK Mounting Hardware for LANmark	106
US Mounting Hardware for LANmark	108
3rd Party Party Compatible Mounting Hardware	110
European Mounting Hardware for Essential Keystone	112
US Mounting Hardware for Essential	114
Voice grade	116
Voice Cables	117
IDC connectivity and accessories	119
Voice Patch Panels	121
Voice Patch Cords	123
Tools & Accessories	125
Tools	126
Keystone Clips	128
Retrofit Hoods	130
Pre-terminated Copper	132
LANmark Pre-Term Bundles	133
LANmark Pre-Term Units	135
LANmark-6A Pre-Term Multipair Cat 6A RJ45 Jack-Jack	137

Optical Fibre	141
Fibre Cables	142
Optical cable specifications	143
LANmark-OF Tight Buffer Indoor	146
LANmark-OF Tight Buffer Universal	149
LANmark-OF Micro-Bundle Indoor	151
LANmark-OF Micro-Bundle Universal (24F-72F)	154
LANmark-OF Micro-Bundle Universal (4F-12F)	157
LANmark-OF UD PE	159
LANmark-OF UC PE	162
LANmark-OF UC LSZH	164
Cables - LANmark-OF ZC LSZH	166
Fibre Connectors & Connector Accessories	168
LANmark-OF Connectors	169
Connector Tools & Accessories	170
Pre-Terminated Fibre Assemblies	172
LANmark-OF OM3, OM4, Singlemode (OS2) Fibre Assembly	173
MPO System	177
LANmark-OF MPO-MPO Pre-Term Trunk for Singlemode OS2, OM3 and OM4	179
LANmark-OF MPO-MPO Slim Pre-Term for Singlemode (OS2), OM3 and OM4	182
LANmark-OF Plug&Play Patch Panels	185
LANmark-OF Plug@Play Module	186
Fibre Patch Panels	188
LANmark-OF Sliding Patch Panels	189
LANmark-OF Sliding Preloaded Patch Panels	191
Essential-OF Fixed Patch Panel	194
Outlets	196
LANmark-OF Zone Distribution box	197
Structural Hardware	199
Patch Cords	201
LANmark-OF Patch Cords	202
Pigtails & Splicing Materials	207
LANmark-OF Splicing Accessories with Aluminium Protectors Preloaded Sliding Panel	208

LANmark-OF Splicing Accessories with Aluminium Protectors Snap-In Panel	211
LANmark-OF Splicing Accessories with Heatshrink Protectors Preloaded Sliding Panel	214
LANmark-OF Splicing Accessories with Heatshrink Protectors Snap-In Patch Panel	217
Splicing Materials & Accessories	220
LANmark-OF Pigtails Maxistrip	222
LANmark-OF Pigtails Tight Buffer	224
Adaptors	226
LANmark-OF Snap-In Adapter	227
Standard Adaptors	229
Tools & Accessories	231
LANmark-OF Cleaning Tools	232
LANmark-OF Fibre Accessories	233
Intelligent Infrastructure Management	235
LANsense Software	236
LANsense EMAC Products	237
LANsense Copper Patch Panels	240
LANsense Copper Patch Cords	242
LANsense Fibre Patch Panels	244
LANsense Fibre Patch Cords	246
LANsense Analysers	248
LANsense Next Generation Analyser	250
LANsense I/O and Master/Link cables	252
LANsense Integration Strips	254
Industrial LAN & Harsh Environments	255
LANmark Industry Copper cables	256
LANmark Industry Optical Fibre cables	258
LANmark Industry DIN-Rail Outlets and boxes	260
LANmark Industry IP65/67 outlets	261
LANmark Industry patch cord RJ45 IP67/IP20 Cat.6	263
General Accessories & Cabinets	265
Datacenter racks and frames	266
Patch Guides, Blank Panels & Cable Management	268
LANmark Zone Distribution Boxes	270

Cabinets - Quick Mount	272
Cabinets - Wall Mountable	274
Cabinet Accessories	276
Miscellaneous Accessories	278
Software, Training, & Services	280
Warranty Services	281
Network Design Tools	282
Training Services	284

Nexans

Nexans is the worldwide leader in the cable industry

With energy as the basis of its development, Nexans is a global player in the infrastructure, industry, building and Local Area Network (LAN) markets.

As a worldwide leader in the cable industry, it offers an extensive range of cables and cabling systems to raise **industrial productivity, improve business performance, enhance security, enrich the quality of life, and assure long-term network reliability.**

With an industrial presence in 39 countries and commercial activities worldwide, Nexans employs 22,700 people and had sales in 2009 of 5 billion euros. Nexans is listed on NYSE Euronext Paris, compartment A. More information on www.nexans.co.uk

Infrastructure

Nexans provides complete cables and cabling solutions for **power transmission and distribution.** New technologies, which are environmentally-friendly, increase capacity and reduce the danger of blackouts.

To reinforce rail safety and efficiency, we have products especially designed for the demanding railroad environment.

And to meet diverse needs of incumbent and new telecoms operators, Nexans has customized solutions aimed at lowering capital expenditure and operating costs.

For the world's busy airports, we offer cables and cabling systems for energy and communication networks, terminals, baggage handling systems, runway lights, control towers, etc.

Industry

Nexans offers a complete portfolio of cables and solutions for market segments as diverse as the **automotive, rolling stock and aerospace industries, shipbuilding, nuclear power, oil & gas and petrochemicals, medical and wind applications, material handling and automation.**

We add value through advanced technologies and durable high-performance products.

Building

Nexans supplies cables and network solutions for structures of all types: from small residences to public and office buildings and big industrial complexes.

Nexans pioneered fire-performance cables for public safety, created industrial Ethernet solutions to unite the office and the factory floor platform, and ensured the highest standards of environmental friendliness and recyclability.

From standard products to renewable energy solutions, these products contribute to the sustainable buildings of the future.

Local Area Networks

Nexans provides copper and optical fiber cabling systems for new resource-intensive applications, like Data Centers, Security services, and Storage Area Networks.

Nexans' advanced solutions are handling core business data, protecting operations in sensitive conditions, and giving organizations highspeed transmission and the ability to protect and retrieve vital information.

Symbols

Minimum dynamic operating bending radius	
Operating temperature, range	
RoHS conform	
Storage temperature, range	
Ambient installation temperature, range	
Fire retardant	
Mechanical resistance to impacts	
Flame retardant	
Minimum static operating bending radius	

LANsystems Introduction

Introduction

Modern structured cabling systems for Local Area Networks (LANs) are in demand wherever data is stored, shared or transferred. LAN cabling systems are considered permanent infrastructure of single or multiple buildings, and therefore must comply with current standards regarding system architecture and channel bandwidth, as well as installation.

LAN system connections are arranged using modern high-capacity components, and designed to be adaptable to meet today's bandwidth needs as well as evolving, higher bandwidth applications of the future. Also, LAN topology and architecture should be sufficiently flexible to easily support the ongoing movement of employees and entire departments.

LAN system needs explained

LANs need to provide the following benefits:

- high capacity communication lines to facilitate a rapid response to growth in a company's data requirements; growth;
- ability to support a wide range of network applications, depending on the System Class, by using standards for data transfer, channel length and connection interfaces;
- well-developed and flexible architecture allowing various network configurations to support new LAN equipment;
- ability to increase the number of nodes using the cabling system's reserves planned for at the design stage;
- reliability offered by resilient backbones, which allow bypassing of damaged network segments;
- high performance, allowing long-term use of the system with easy migration paths

How Nexans addresses LAN needs

Nexans Cabling Solutions (NCS) provides exceptional infrastructure design, products, maintenance and support for LANs worldwide. Nexans' products set the standards in their class. The company constantly improves its products and technologies at its own research facility, aided by professionals in the field of data transfer systems and solutions.

Every Nexans' LAN component meets all current standards, yet at the same time, are unique creations in design, features and customer advantages. The company is among the world leaders in the telecommunications equipment market.

Automated assembly processes for the most sensitive cable communication equipment ensure high quality installation. And superior line and channel properties help ensure a level of reliability exemplified by a 25-year warranty on applications and component quality. Official Certified System Partners also offer a highly competitive labour-cost warranty.

LAN Standards

International LAN standards

One of the principal international documents defining LANs is ISO/IEC 11801. This is a joint standard by the International Standards Organisation (ISO) and the International Electrotechnical Commission (IEC). ISO/IEC 11801 sets a standard for structured cabling systems installed in customers' buildings and premises. The requirements apply primarily to administrative or commercial structures. In modern office facilities, however, it is typical to exchange data with a warehouse or production facility, and the recommendations in ISO/IEC 11801 cover such applications as well.

The standard defines the main characteristics of cabling systems including its architecture, cables and connectors, cable parameters, as well as the length and bandwidth of links and channels.

In order to understand the principles of selecting and using cabling systems for transferring data, voice, video or any other information, it is important to read the standards and recommendations in the September, 2002, edition of ISO/IEC 11801, as well as the amendments of 2010. This section provides a brief overview of these requirements as applied to the products in this catalogue.

LAN Topology and Architecture

The basis of LAN topology is depicted by the master-slave star architecture, also known as 'tree' topology. Junctions in such architecture are the distributors, and connecting and/or switching equipment supporting various distribution roles.

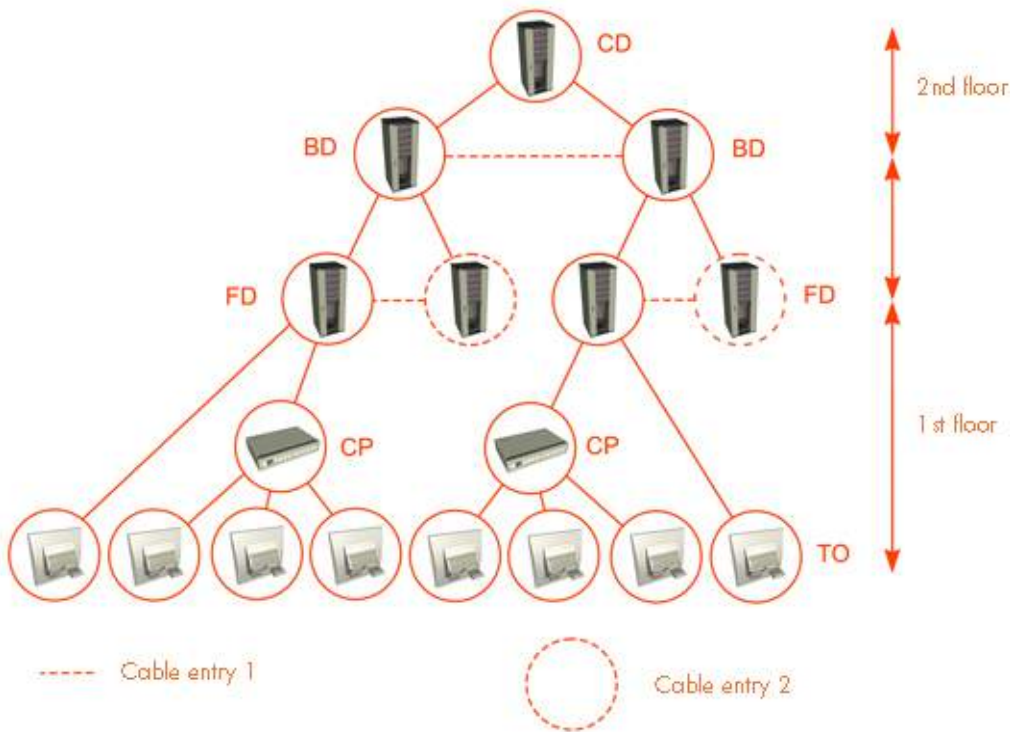

Fig. 1. Hierarchy of a typical LAN cabling system.

- CD – Campus Distributor
- BD - Building Distributor
- FD – Floor Distributor
- CP – Consolidation Point
- TO – Telecommunications Outlet

Structured cabling connects switches, computers and increasingly, devices like telephones and IP cameras. LANs should therefore have a high degree of flexibility to support widely diverse connections as well as the ability to respond promptly to changeable requirements for the physical channel configuration.

Distributors

Patch panels are mounted on racks or in cabinets, and can also be installed beneath floors or behind walls. Normally, the cabinets also house power supply units and various accessories facilitating labels and administration. The cabling system distributors are usually installed in separate technical rooms.

A LAN serving a multi-storey building may have split backbones, each one independent but still forming a star hierarchy. Should the need arise, its communication lines can be directly connected to another backbone. It is possible to reduce the number of backbone links and distributors depending on available space and the number of users. Certain distributors of various levels can also be combined into one. In order to improve the system's reliability, distributors of one level, together with connected lines, can be replicated in various parts of the building. In this case, the user's telecommunication outlets will be connected to separate distributors.

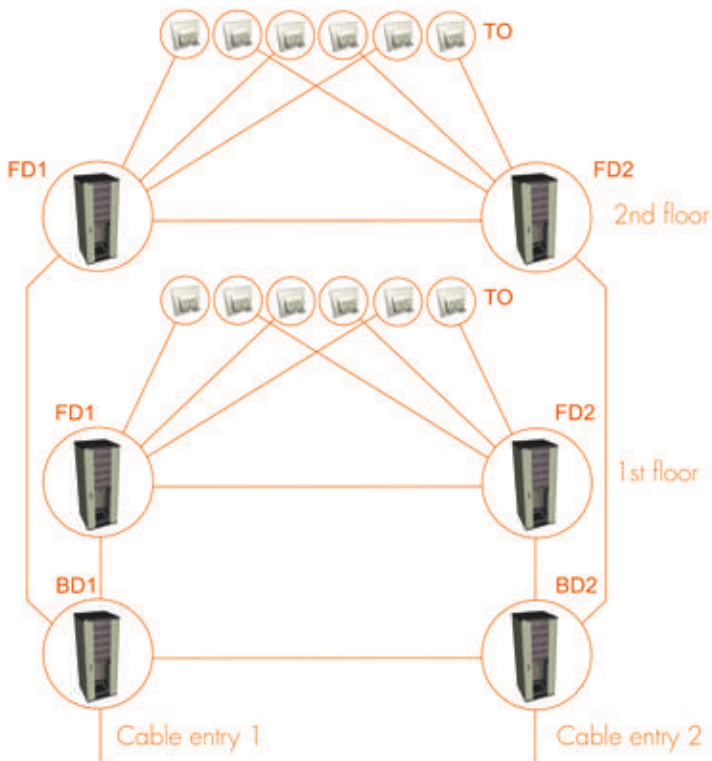

Fig. 2. Hierarchy of a typical LAN cabling system.

BD1,2 - Building Distributor
 FD1,2 – Floor Distributor
 TO – Telecommunications Outlet

In cases where two or more buildings are connected using a single cabling infrastructure, the LAN will have three sections: campus backbone, building backbone, and horizontal cabling (Fig.3).

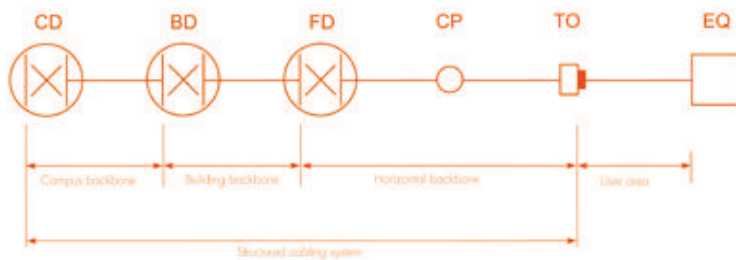

Fig. 3. Hierarchy of a typical LAN cabling system.

CD – Campus Distributor
 BD - Building Distributor
 FD – Floor Distributor
 CP – Consolidation Point
 TO – Telecommunications Outlet
 TE – Terminal Equipment

Backbones

The Campus backbone connects the Campus distributor with the Building distributors through panels and switches, to which the cables are connected; and patch cords or jumpers. ISO/IEC 11801 provides for entry points to the backbone which facilitate the entry and termination of cables inside the building. These include cables supporting telephone, Internet, cable TV, or technical monitoring systems.

The campus distributor can be housed in the same structure as the building distributor, or even in the same technical room as the floor distributor. Such technical rooms are called equipment rooms, and its respective requirements are set out by ISO/IEC TR 14763-2 (Fig.4).

The building (or vertical) backbone connects separate floor distributors to the building distributor. The building backbone consists of internal trunk cables, patch panels and patch cords for connections within the building distributor.

Horizontal cabling (or floor-by-floor distribution) connects the floor distributor with desktop or telecommunication outlets (TO's). A consolidation point can also be part of the horizontal cabling in cases of zonal distribution.

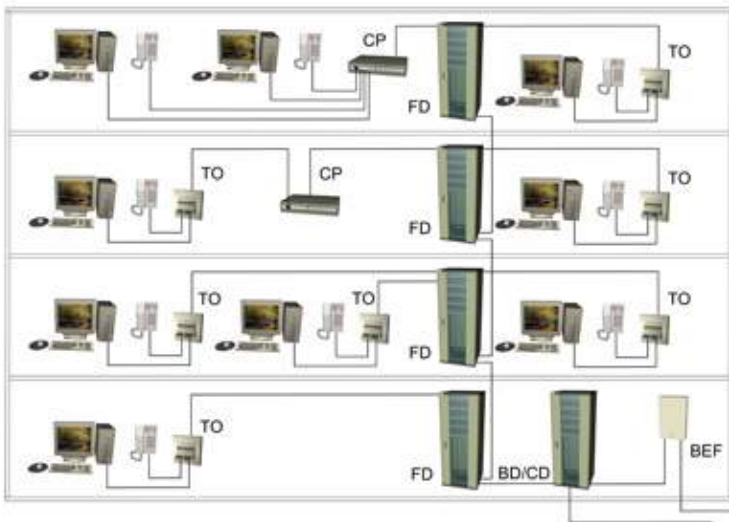

Fig. 4. Location of distributors in a typical cabling system within a building.

- CD- Campus Distributor
- BD – Building Distributor
- FD – Floor Distributor
- CP – Consolidation Point
- TO – Telecommunication Outlet
- ER – Equipment Room
- BEF – Building Entrance Facility

Cross- and direct-connect explained

The connection between active equipment and backbone or horizontal cables can be build with a degree of flexibility. The most flexible solution is the cross-connect (see Fig.5).

In addition to improving system administration, this solution allows the splitting of specialists' areas of responsibility and facilitates equipment maintenance. However, adding connectors to the communication channel can impair its characteristics.

The alternative to a cross-connect is an interconnect (Fig.6 - next page.)

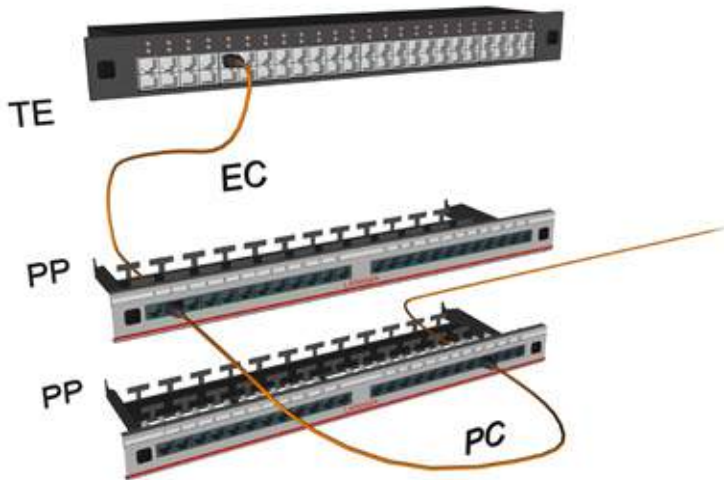

Fig. 5. Example of cross-connect type

TE – Telecommunications Equipment
 PP – Patch Panel
 EC – Equipment Cord
 PC – Patch Cord

In addition to backbones, the standard specifies connections to the desktop or Work Area. ISO/IEC TR 14763-2 requires up to 10m² for the Work Area, i.e. where the end-user equipment is connected to the telecommunication outlets. In certain cases, the Work Area can be organised more compactly, providing 4-6 m² per user. According to ISO/IEC 11801, at least two telecommunication outlets must be provided for each user.

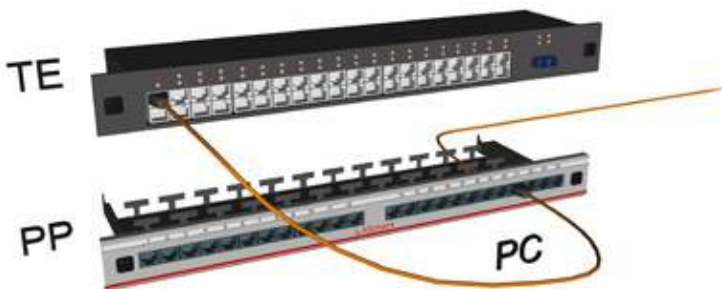

Fig. 6. Example of interconnect type

TE – Telecommunications Equipment
 PP – Patch Panel
 EC – Equipment Cord
 PC – Patch Cord

The number of Floor Distributors (FD) depends on the area to be covered or the number of workplaces per area. Generally, the standard recommends at least one FD for every 1 000 m² of office area.

The physical length of a horizontal copper channel is maximized to 100 m. The total length of sections including backbones should not exceed 2 000 m.

Designing LANs for high speed

Supporting high speed protocols such as Fast Ethernet, 100Base-TX and Gigabit Ethernet 1000Base-T requires a minimum of Class D performance. In order to meet Class D requirements, the components of Cat. 5e cabling should adhere to specifications of the second edition of the ISO/IEC 11801 standard, issued in 2002. As an alternative, installing Class E, Ea, F and Fa systems within a horizontal cabling are permissible: these require components of Cat. 6, 6A, 7 and 7A respectively. These solutions provide a high bandwidth reserve for future applications.

Nexans Cabling Solutions offers LANmark-5, 6, 6A, 7 and 7A systems. Detailed product information for these systems can be found in this catalogue's respective sections.

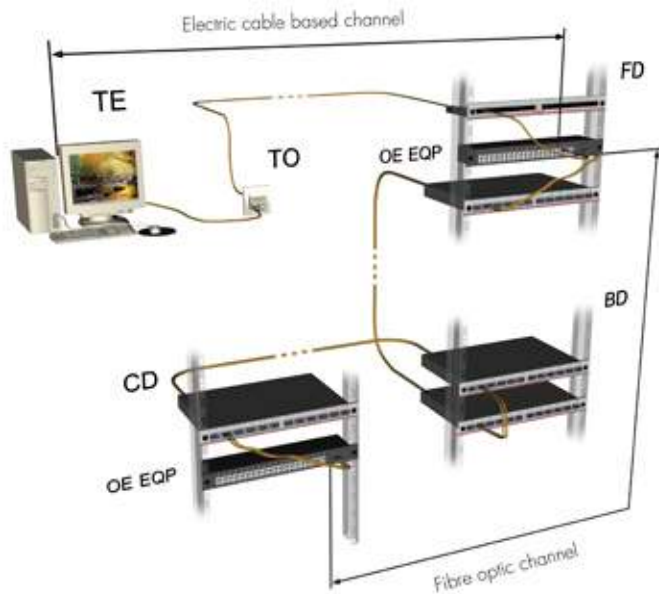

Fig. 7. The use of transfer medium in a typical LAN cabling system.

- CD – Campus Distributor
- BD – Building Distributor
- FD – Floor Distributor
- CP – Consolidation Point
- TO – Telecommunication Outlet
- TE – Terminal Equipment
- OE EQP – Opto-electronic equipment

The most important general requirements of ISO/IEC 11801:2002 for twisted pair media are:

- Cables used for Class D, E, Ea, F and Fa systems must have rated characteristic impedance of 100 Ohms;
- Connectors at the 'TO' side must correspond to connector standard RJ45 (IEC 60603-7) for Cat. 5e, 6 and 6A, and to connector standard GG45 (IEC 60603-7-7) for Cat. 7 and 7A.

Fibre optic cabling applications

The standard recommends fibre optic cable for campus -and building backbones. Its' low signal attenuation, immunity to electromagnetic disturbances and galvanic separation between buildings make fibre a strong alternative. The core of fibre optic cables, can be produced from multi-mode (MM) fibres sized 50/125 mm and 62.5/125 mm with graded index profile, and single-mode (SM) fibres sized 9/125 mm with step index profile. Detailed information on Nexans fibre optic cable specifications is in the section "LANmark-OF Optical Systems".

The standard further recommends the SC- and LC-connectivity as the optical fibre connector interface for all LAN backbones. However, if a higher concentration of connections is required, the standard permits Small Form Factor connectors (SFF) which requires LC connectors.

Design Considerations

Layouts of Horizontal Channels

The standard allows the use of four channel types within a horizontal distribution to connect user equipment as well as network telecom equipment (see structure below.)

The simplest channel type is shown in Layout A (Fig. 8). The most flexible and complex channel type in a horizontal distribution is shown in Layout D.

Horizontal channel links have the following limitations:

- Physical length of the channel must not exceed 100 m;
- Physical length of horizontal cable used to build a communication line must not exceed 90 m, depending on the total length of patch cords;
- If total length of patch and equipment cords exceeds 10 m, the length of the horizontal cable must be proportionally reduced according to the algorithm detailed in the standard;
- When using a Consolidation Point (CP) for zonal distribution, it must be installed at least 15 m from the Floor Distributor (FD).

Besides these limitations, the following recommendations for the horizontal backbone should be noted:

- When using a Multi-User Telecommunication Outlet (MUTO), the length of the equipment cord connecting the terminal equipment should not exceed 20 m;
- Recommended length of patch cords is up to 5 m.

These recommendations allow the use of longer cords should the need arise.

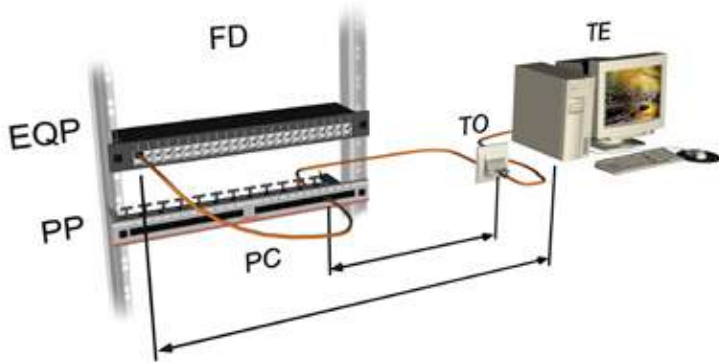

Layout A: Interconnect-TO type

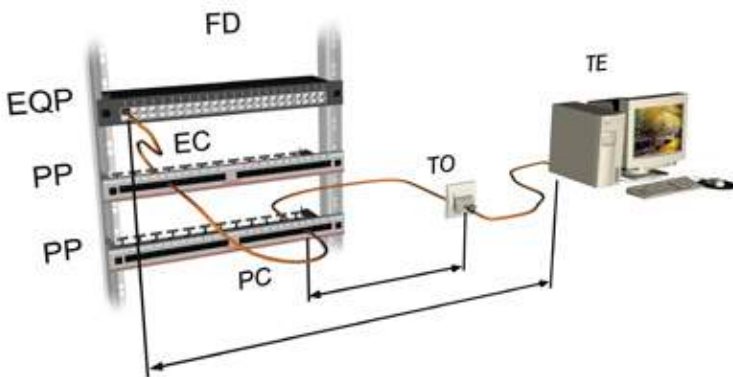

Layout B: Crossconnect-TO type

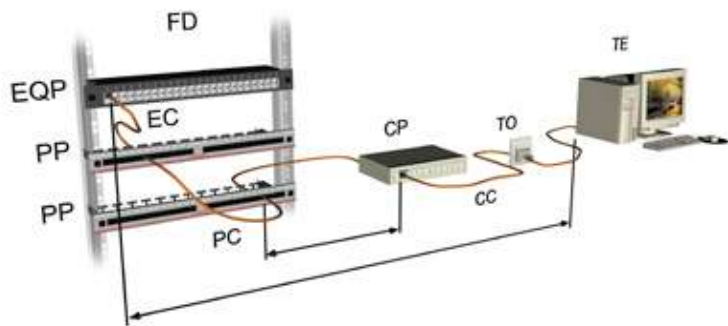

Layout C: Interconnect-CP-TO type

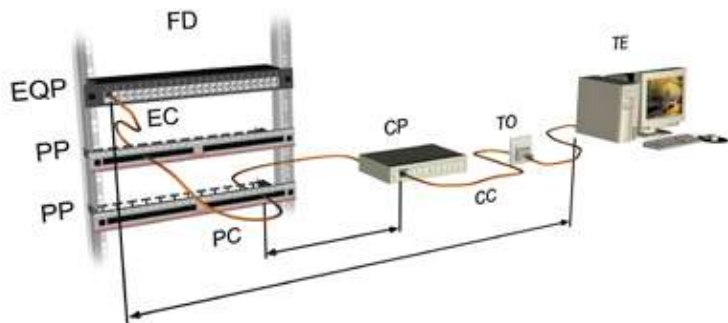

Layout D: Crossconnect-CP-TO type

Fig. 8. Possible layouts of horizontal backbone channels

- BD – Building Distributors
- FD – Floor Distributor
- CP – Consolidation Point
- TO – Telecommunication Outlet
- TE – Terminal Equipment
- PC – Patch Cord
- EC – Equipment Cord
- CC – Consolidation Point Cable

If a twisted pair based system is used, the most complex and flexible layout is a 4-connector channel (Fig. 9).

The principal limitations for Class D, E, Ea, F and Fa backbone communication channels are:

- Physical length of the channel must not exceed 100 m;
- When using 3 connectors along the channel, the installation or mounting cable must be at least 15 m long.

Depending on the total length of patch cords, the mounting cable's length must be proportionally decreased. To calculate mounting cable length, remember to account for patch and equipment cord length, as well as the category of components and the required channel class. ISO/IEC 11801 provides calculation algorithms

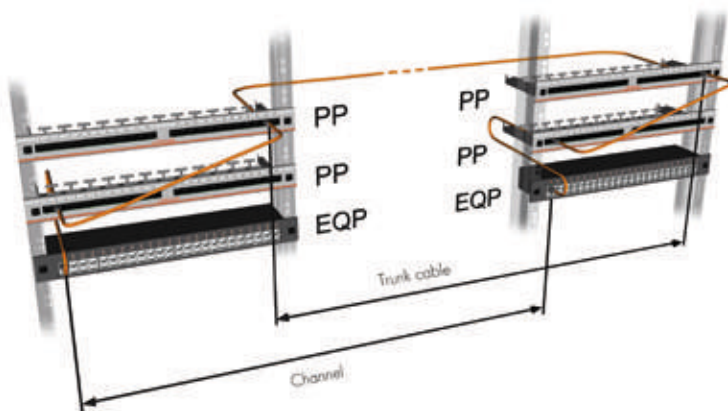

Fig. 9. Typical layout of communication backbone channel.

CD – Campus Distributor
 BD – Building Distributor
 FD – Floor Distributor
 PP – Patch Panel
 EQP – Equipment

LAYOUTS OF FIBRE OPTIC-BASED CHANNELS

Due to low signal attenuation when using fibre optics, it is possible to connect the communication lines of different backbones in a single transmission channel. The following types of combined fibre channels are possible:

- Patched channel allowing cross-connection of lines belonging to different, adjoining backbones (Fig. 10);
- Collapsed backbone model creating a direct link between BD and TO limited to a distance of 300m and only with MM fibre.

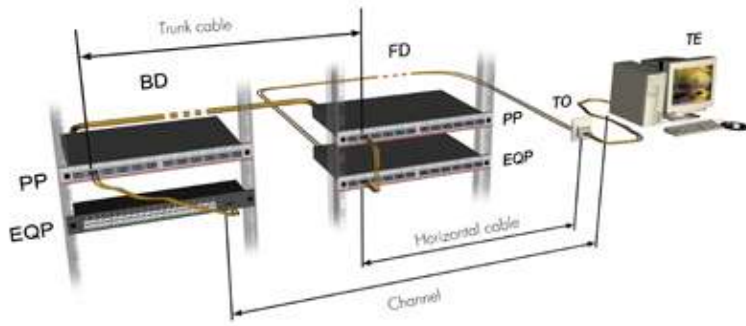

Fig. 10. Patched combined channel layout.

- BD – Building Distributors
- FD – Floor Distributor
- PP – Patch Panel
- TO – Telecommunication Outlet
- EQP - Equipment
- CC - Consolidation Point Cable
- TE - Terminal Equipment

LAN Cabling Systems

Nexans provide a full range of LAN cabling solutions & services.

- **LANsense** : Intelligent Infrastructure Management (IIM) including **EMAC** Environmental Monitoring & Access Control
- **LANmark** : Passive LAN infrastructure solutions
- **essential**: component based cabling products
- **Software, Services & Support Tools**

Please see the link to LAN Systems Main webpages for support documentation and tools.

A vertical stack of three logos: 'LANsense' in red and black, 'LANmark' in red and black, and 'essential' in red and black.

Copper

Nexans offer the full range of copper LAN systems to ensure we can provide the solution most suited for your needs.

- All performance levels: Cat 5e, Cat 6, Cat 7 & voice grade
- All construction types : UTP, FTP, S-FTP, PIMF
- Modular connectivity based on 'Snap-in' and '808' connectivity
- Guaranteed Application support with extended distance



Category 5e

Nexans offer a choice of Category 5e ranges:

Full System Offer

LANmark-5

- Cat 5e system based on snap-in format connectivity

LANconnect-5

- Cat 5e system based on 808 style connectivity. Extended distance support is possible using 'LANconnect PLUS' cables.

All complete systems offer a comprehensive Certified System Parts & LABOUR Warranty.

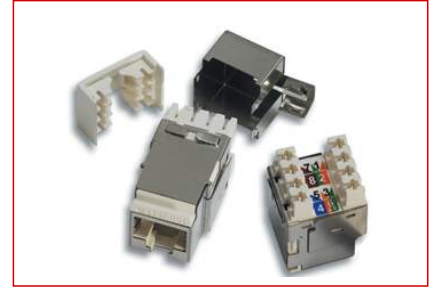

Component based solution

Essential - component based 'economy without compromise'

- cost effective solution for basic installations
- instant downloadable Nexans Link Certificate.

LANmark-5 Cable

- Offers headroom to Category 5e standards
- Performance guaranteed to 155MHz
- Supports Gigabit Ethernet

Description

Application

Nexans LANconnect/LANmark-5 cable is designed to provide additional performance and bandwidth over and above the basic requirements of Category 5e. With modern high speed applications, installation effects can have a serious influence on the initial cable performance and therefore without sufficient headroom, problems can arise. The addition of transition points within the link can also lead to additional losses. Nexans LANconnect/LANmark-5 provides the additional headroom necessary to ensure that applications such as Gigabit Ethernet can run efficiently after installation. It is available in Grey PVC or Orange LSZH.

Performance

With guaranteed performance to 155MHz, Nexans LANconnect/LANmark-5 cables provide guaranteed additional headroom and bandwidth over and above the requirements of TIA 568-B and IEC 61156-5.

Guarantees

Nexans LANconnect/LANmark-5 cables are covered by the guarantee that they are Category 5e and by a parts and labour warranty as described in the Nexans Certified System Warranty. Moreover they come with following guarantees:

- 3dB min. headroom over IEC 61156-5 and TIA 568-B Cat 5e NEXT
- Improved ACR
- Superior EMC performance
- 155MHz guaranteed performance
- When used in a full LANmark system, full LANmark D channel warranty can be obtained.

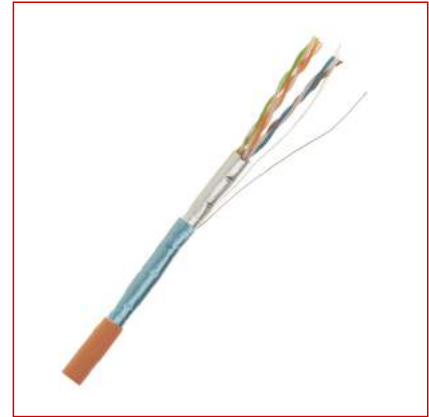

LANmark-5

Standards

International ISO/IEC 11801; ISO/IEC 61156-5

National TIA/EIA-568-B.2



RoHS conform
Yes

LANmark-5 Cable

Characteristics

Electrical characteristics	
Transfer impedance	20
Characteristic impedance	100 Ohm
Transmission characteristics	
Propagation delay, max. 100 MHz	536 ns/100m
Usage characteristics	
Range	LANmark-5
RoHS conform	Yes

Product List

☎ = Make to order, 📦 = Make to stock

Nexans ref.	Name	Type of cable	Category	Outer sheath	Flame retardant
📦 N100.403	LANconnect/LANmark-5 F ² /UTP Dual LSZH 500m Reel	F ² TP Shotgun	Cat. 5e	LSZH	IEC 60332-1
☎ N100.413	LANconnect/LANmark-5 F ² /UTP Dual PVC 500m Reel	F ² TP Shotgun	Cat. 5e	PVC	IEC 60332-1
📦 N100.402	LANconnect/LANmark-5 F ² /UTP LSZH 1000m Reel	F ² TP	Cat. 5e	LSZH	IEC 60332-1
📦 N100.421	LANconnect/LANmark-5 F ² /UTP LSZH 500m Reel	F ² TP	Cat. 5e	LSZH	IEC 60332-1
📦 N100.412	LANconnect/LANmark-5 F ² /UTP PVC 1000m Reel	F ² TP	Cat. 5e	PVC	IEC 60332-1
📦 N100.431	LANconnect/LANmark-5 F ² /UTP PVC 500m Reel	F ² TP	Cat. 5e	PVC	IEC 60332-1
☎ N100.493	LANconnect/LANmark-5 F ¹ /UTP Dual LSZH 500m Reel	F/UTP Shotgun	Cat. 5e	LSZH	IEC 60332-1
☎ N100.443	LANconnect/LANmark-5 F ¹ /UTP Dual PVC 500m Reel	F/UTP Shotgun	Cat. 5e	PVC	IEC 60332-1
📦 N100.492	LANconnect/LANmark-5 F ¹ /UTP LSZH 1000m Reel	F/UTP	Cat. 5e	LSZH	IEC 60332-1
📦 N100.491	LANconnect/LANmark-5 F ¹ /UTP LSZH 305m Box	F/UTP	Cat. 5e	LSZH	IEC 60332-1
📦 N100.494	LANconnect/LANmark-5 F ¹ /UTP LSZH 500m Reel	F/UTP	Cat. 5e	LSZH	IEC 60332-1
📦 N100.442	LANconnect/LANmark-5 F ¹ /UTP PVC 1000m Reel	F/UTP	Cat. 5e	PVC	IEC 60332-1
📦 N100.441	LANconnect/LANmark-5 F ¹ /UTP PVC 305m Box	F/UTP	Cat. 5e	PVC	IEC 60332-1
📦 N100.444	LANconnect/LANmark-5 F ¹ /UTP PVC 500m Reel	F/UTP	Cat. 5e	PVC	IEC 60332-1
📦 N100.502	LANconnect/LANmark-5 U/UTP LSZH 1000m Reel	U/UTP	Cat. 5e	LSZH	IEC 60332-1
📦 N100.507	LANconnect/LANmark-5 U/UTP LSZH 305m Box	U/UTP	Cat. 5e	LSZH	IEC 60332-1
📦 N100.521	LANconnect/LANmark-5 U/UTP LSZH 500m Reel	U/UTP	Cat. 5e	LSZH	IEC 60332-1
📦 N100.512	LANconnect/LANmark-5 U/UTP PVC 1000m Reel	U/UTP	Cat. 5e	PVC	IEC 60332-1
📦 N100.517	LANconnect/LANmark-5 U/UTP PVC 305m Box	U/UTP	Cat. 5e	PVC	IEC 60332-1
📦 N100.522	LANconnect/LANmark-5 U/UTP PVC 500m Reel	U/UTP	Cat. 5e	PVC	IEC 60332-1

☎ = Make to order, 📦 = Make to stock

LANmark-5 Cable

Electrical Performance

all values are specified at 20°C

Frequency	Attenuation dB/100m	NEXT dB	ACR dB/100m	PSNEXT(*) dB	ELFEXT dB/100m	PSELFEXT dB/100m	RL dB
1	2.1	68.3	66.2	65.3	63.8	61.0	20.0
4	4.0	59.3	55.3	56.3	51.7	49.0	23.0
10	6.3	53.3	47.0	50.3	43.8	41.0	25.0
16	8.0	50.3	42.3	47.3	39.7	36.9	25.0
20	9.0	48.8	39.8	45.8	37.7	35.0	25.0
31.25	11.4	45.9	34.5	42.9	33.9	31.1	23.6
62.5	16.5	41.4	24.9	38.4	27.9	25.1	21.5
100	21.3	38.3	17.0	35.3	23.8	21.0	20.1
155	27.2	35.5	8.3	32.5	19.9	17.2	18.7

(*) Dual cable versions additionally comply to the additional PSNEXT requirements for multi-unit cables as specified in the relevant TIA and IEC cable standards.

Selling delivery information

Installation: Nexans LANconnect/LANmark-5 cables are designed to be installer friendly. The additional performance headroom provides confidence for difficult installations.

LANmark-5 Snap-In connector

- Available in Screened and Unscreened version
- Version for stranded wire available, both in Screened and Unscreened
- No punchdown tool needed for termination
- Reduced risk of installation errors gives consistent performance
- Compatible with all Snap-in hardware
- Compatible with keystone format using additional clip

Description

Application

The LANmark-5 Snap-in connector range is part of the Nexans modular system and fits in all structural hardware designed for this range. As such it supports all data applications defined for Cat 5 and Cat 5e, such as 10baseT, Fast Ethernet, Gigabit Ethernet, 155 ATM.

Performance

The LANmark-5 Snap-in connector is designed to reach the highest performance in Cat5e. It has outstanding performance for attenuation (insertion loss), NEXT/FEXT, Power Sum NEXT/FEXT and Return Loss, exceeding the Cat 5e connector specs as in ISO/IEC 11801:2002. Used with Nexans LANmark-5 cable and patchcords, the connector is tested to exceed the link and stringent four-conductor channel requirements as defined in the ISO/IEC 11801:2002 standard.

Guarantees

The LANmark-5 Snap-in connector range is covered by the Nexans guarantee conform The General Terms and Conditions of Sales. In combination with the Nexans LANmark-5 product range, the Nexans Certified System Warranty can be obtained, covering parts, system and labour.

Installation

The LANmark-5 Snap-in connector range is designed to be terminated by hand, without punchdown tool. The exclusive construction of the wire organizer makes termination fast and self-evident. To allow an even quicker and easier installation, an optional comfort tool can be used (N420.567). This tool includes an extraction mechanism which makes the connector re-usable. The LANmark-5 snap-in range is Nexans technology inside and user friendly outside.

- Fast and easy termination thanks to wire organiser
- No punchdown tool needed
- Colour code : T568A and T568B
- Re-usable with universal comfort tool (N420.567)
- Fits in all Nexans structural hardware for snap-in format
- Different versions available: for solid wire and for stranded wire, both in screened and unscreened version.



LANmark-5

Standards

International ISO/IEC 11801
National TIA/EIA-568-B.2

LANmark-5 Snap-In connector

Characteristics

Construction characteristics	
Connector type	RJ45 and Tool-less IDC
Dimensional characteristics	
Width	17 mm
Usage characteristics	
Range	LANmark-5

Product List

☎ = Make to order, 📦 = Make to stock

Nexans ref.	Name	Height (mm)	Screen
📦 N420.555	LANmark-5 Screened Snap-In connector	23.2	Yes
☎ N420.556	LANmark-5 Screened Snap-In connector for stranded wire	23.2	Yes
📦 N420.550	LANmark-5 Unscreened Snap-In connector	22.9	No
☎ N420.551	LANmark-5 Unscreened Snap-In connector for stranded wire	22.9	No

☎ = Make to order, 📦 = Make to stock

LANmark-5 Patch Panels

- Offers headroom to latest Category 5e standard
- Sliding mechanism version: easy access from front side and including marking strip
- Top connection version supplied with an integrated cable management plate for tie wrap
- LSA+/110 IDC compatible termination
- included marking strip
- Screened and unshielded version
- Suitable for 4 twisted pairs LAN cable and for Voice multipairs cable : access from rear or from side

Description

Application

The LANmark-5 1HU twisted pair patch panel is based on 19" frame dimensions. In the sliding mechanism version, it is easy to manage thanks to the integrated Clip-on. In the top connection version, it is easy to manage thanks to the integrated cable management plate. Both versions provide reliable cable retention and grounding. The use of patch guides (sold separately) allows an orderly arrangement of patchcords.

Performance

The LANmark-5 connector has been designed to reach the highest in Cat 5E performance. It has outstanding performances for attenuation (insertion loss), NEXT/FEXT per pair, Power Sum NEXT/FEXT and RETURN LOSS. The LANmark-5 connector module is independently tested and when used with LANmark-5 cable and patchcords, the 4 connector channel exceeds the Class D requirements as defined in the ISO/IEC11801 : 2002

Guarantees

The LANmark-5 PCB patch panel is fully compliant with the ISO/IEC11801 : 2002 and exceeds all parameters with large headroom. In combination with the Nexans LANmark product range, this patch panel offers you a full Class D warranted solution.

Installation

The patch panel is equipped with a sliding mechanism or with an integrated cable management plate for easy front access when mounted into a cabinet. This time saving mechanism facilitates front side termination.

- Easy to install and modify: all operations are performed at the front side.
- Supplied with fixings.
- Available with Nexans LSA+/110 IDC compatible terminations.
- Unshielded and shielded versions available.
- Suitable for multipairs cable
- 9 pins IDC block for easy termination of drain wire for screened version or 8 pins IDC block for unshielded version
- Colour code T568A and T568B.
- Can be used with all types of cables : F2TP, UTP, S-FTP and STP.
- Accepts 24, 23 and 22 AWG cables.



LANmark-5

Standards





International ISO/IEC 11801



LANmark-5 Patch Panels

Characteristics

Dimensional characteristics	
Heightunit	1 U
Usage characteristics	
Category	Cat. 5e
Range	LANmark-5
Number of ports	24

Product List

Nexans ref.	Name	Screen	Depth (mm)
 N500.115	LANmark 5 Sliding PCB Patch Panel Screened	Yes	170
 N500.215	LANmark-5 Fixed PCB Patch Panel Screened	Yes	137
 N500.205	LANmark-5 Fixed PCB Patch Panel Unscreened	No	137
 N500.105	LANmark-5 Sliding PCB Patch Panel Unscreened	No	170

 = Make to order,  = Make to stock

LANmark-5 Outlet 45x45

- Offers headroom to latest Category 5e standard.
- LSA+ termination
- Screened and unshielded version
- Single and double connection available
- Fits in Nexans structural hardware.

Description

Features

Full Category 5 outlets with better than 40 dB NEXT at 100 MHz between every pair combination. RJ45 ISO 8877 compliant outlets with T 568B and T 568A pin configuration.

Fast Foolproof installation:

- IDC contacts at frontside for convenient installation
- IDC colour coding in conformity with cable colour coding

Integrated Outlet Labelling System for easy management and identification

- Labelling window supplied

Versions available: single and double RJ45 connectors, screened and unshielded.

Country specific covering plates adapt to national requirements and designs.

The connector module is designed to be compatible with any covering plate by using adaptation rings if required.

These modules fit into a complete range of international Covering Plates.

All plastic material is UL 94V0.

Values

Min. Next Loss (dB)	40
Min. Return Loss (dB)	14

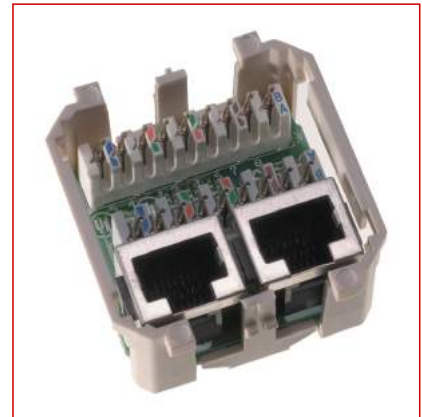

LANmark-5

Standards

International ISO/IEC 11801

LANmark-5 Outlet 45x45

Characteristics

Construction characteristics	
Connector type	RJ45 and LSA+ IDC
Dimensional characteristics	
External dimensions	45 (H)x 45 (W) x 16(D)mm
Transmission characteristics	
Attenuation, max. 100 MHz	0.40 dB/100m
Usage characteristics	
Range	LANmark-5

Product List

☎ = Make to order, 📦 = Make to stock

Nexans ref.	Name	Colour	Screen
📦 N462.211	LANmark-5 Double Outlet 45x45 Screened Ivory with Shutter	Ivory	No
📦 N462.210	LANmark-5 Double Outlet 45x45 Screened White with Shutter	White RAL 9010	Yes
📦 N462.201	LANmark-5 Double Outlet 45x45 Unscreened Ivory with Shutter	Ivory	Yes
📦 N462.200	LANmark-5 Double Outlet 45x45 Unscreened White with Shutter	White RAL 9010	No
📦 N462.111	LANmark-5 Single Outlet 45x45 Screened Ivory with Shutter	Ivory	Yes
📦 N462.110	LANmark-5 Single Outlet 45x45 Screened White with Shutter	White RAL 9010	Yes
📦 N462.101	LANmark-5 Single Outlet 45x45 Unscreened Ivory with Shutter	Ivory	No
📦 N462.100	LANmark-5 Single Outlet 45x45 Unscreened White with Shutter	White RAL 9010	No

☎ = Make to order, 📦 = Make to stock

LANmark-5 UniBoot Patch Cords

- Complies fully with Category 5 standards
- Uses Nexans cable technology
- Fully matched with other components for maximum performance
- LSZH Flame retardant jacket or PVC
- Retrofit Latch Protector available in 8 colours for colour coding

Description

Application

This full Category 5e patch cord maximises the full performance of the channel and will exceed the requirements of the ISO/IEC 4-connector model, when used as part of a LANmark-5 cabling Class D solution. This provides improved data throughput and allows for the inclusion of a Cross-Connect or Consolidation Points for maximum system flexibility.

Screened and unshielded versions available.

LANmark-5 Patch Cords feature a slim over-moulded boot for mechanical protection, which is kept inside the RJ45 boundaries to enable high density patching with 48 cords in 1 height unit. A 'Retrofittable' Latch Protector is available as accessory, which can be used for colour coding of different services.

Guarantees

- When used with the LANmark-5 system, Cat 5e/Class D channel performance complies with the channel limits of TIA/EIA-568B and ISO/IEC 11801: 2002 and a 25 years channel warranty can be obtained.
- Reliable connections.

Usage

- Small cross section allows neat installation and simplifies the creation of bundles in cabinets.
- Low Smoke Halogen Free - Flame Retardant and PVC jackets are standard.
- 1, 2, 3, 5, 10 and 20m are standard lengths available from stock; other lengths are available on demand.
- Orange for LSZH and Dark Grey for PVC are standard colours; other colours (Red, Blue, Yellow and Green) are available on request (in PVC only).
- Rugged construction.
- High connector retention force due to moulded connectors.
- External strain relief.
- Self-latching, high reliability RJ45 (ISO 8877) connectors.



LANmark-5

Standards

International ISO/IEC 11801

National TIA/EIA-568-B.2





















LANmark-5 UniBoot Patch Cords

Characteristics

Dimensional characteristics	
Nominal outer diameter	5.5 mm
Electrical characteristics	
Characteristic impedance	100 Ohm
Usage characteristics	
Range	LANmark-5
Mechanical durability/matings	750

Product List

☎ = Make to order, 📦 = Make to stock

Nexans ref.	Name	Outer sheath	Length (m)	Colour	Screen
 N115.P1B100OU New	LANmark-5 Patch Cord Cat 5e Screened LSZH 10m Orange	LSZH	10	Orange	Yes
 N115.P1B010OU New	LANmark-5 Patch Cord Cat 5e Screened LSZH 1m Orange	LSZH	1	Orange	Yes
 N115.P1B200OU New	LANmark-5 Patch Cord Cat 5e Screened LSZH 20m Orange	LSZH	20	Orange	Yes
 N115.P1B020OU New	LANmark-5 Patch Cord Cat 5e Screened LSZH 2m Orange	LSZH	2	Orange	Yes
 N115.P1B030OU New	LANmark-5 Patch Cord Cat 5e Screened LSZH 3m Orange	LSZH	3	Orange	Yes
 N115.P1B050OU New	LANmark-5 Patch Cord Cat 5e Screened LSZH 5m Orange	LSZH	5	Orange	Yes
 N115.P2B100DU New	LANmark-5 Patch Cord Cat 5e Screened PVC 10m Grey	PVC	10	Grey	Yes
 N115.P2B010DU New	LANmark-5 Patch Cord Cat 5e Screened PVC 1m Grey	PVC	1	Grey	Yes
 N115.P2B200DU New	LANmark-5 Patch Cord Cat 5e Screened PVC 20m Grey	PVC	20	Grey	Yes
 N115.P2B020DU New	LANmark-5 Patch Cord Cat 5e Screened PVC 2m Grey	PVC	2	Grey	Yes
 N115.P2B030DU New	LANmark-5 Patch Cord Cat 5e Screened PVC 3m Grey	PVC	3	Grey	Yes
 N115.P2B050DU New	LANmark-5 Patch Cord Cat 5e Screened PVC 5m Grey	PVC	5	Grey	Yes
 N115.P1A100OU New	LANmark-5 Patch Cord Cat 5e Unscreened LSZH 10m Orange	LSZH	10	Orange	No
 N115.P1A010OU New	LANmark-5 Patch Cord Cat 5e Unscreened LSZH 1m Orange	LSZH	1	Orange	No
 N115.P1A200OU New	LANmark-5 Patch Cord Cat 5e Unscreened LSZH 20m Orange	LSZH	20	Orange	No
 N115.P1A020OU New	LANmark-5 Patch Cord Cat 5e Unscreened LSZH 2m Orange	LSZH	2	Orange	No
 N115.P1A030OU New	LANmark-5 Patch Cord Cat 5e Unscreened LSZH 3m Orange	LSZH	3	Orange	No
 N115.P1A050OU New	LANmark-5 Patch Cord Cat 5e Unscreened LSZH 5m Orange	LSZH	5	Orange	No
 N115.P2A100DU New	LANmark-5 Patch Cord Cat 5e Unscreened PVC 10m Grey	PVC	10	Grey	No
 N115.P2A010DU New	LANmark-5 Patch Cord Cat 5e Unscreened PVC 1m Grey	PVC	1	Grey	No

☎ = Make to order, 📦 = Make to stock

LANmark-5 UniBoot Patch Cords

Nexans ref.	Name	Outer sheath	Length (m)	Colour	Screen
 N115.P2A200DU New	LANmark-5 Patch Cord Cat 5e Unscreened PVC 20m Grey	PVC	20	Grey	No
 N115.P2A020DU New	LANmark-5 Patch Cord Cat 5e Unscreened PVC 2m Grey	PVC	2	Grey	No
 N115.P2A030DU New	LANmark-5 Patch Cord Cat 5e Unscreened PVC 3m Grey	PVC	3	Grey	No
 N115.P2A050DU New	LANmark-5 Patch Cord Cat 5e Unscreened PVC 5m Grey	PVC	5	Grey	No
		☎ = Make to order, 📦 = Make to stock			

Essential Cat 5e Cable

- U/UTP, F/UTP & SF/UTP construction
- Complies to latest Cat 5E standards
- Supports Gigabit Ethernet
- Guaranteed performance to 100MHz
- Single foil offers EMC performance

Description

Application

Category 5e cables are the standard 100MHz offering from Nexans. Manufactured in accordance with TIA 568-B and IEC 61156-5, they are suitable for basic voice & data installations. Available in Light Grey PVC or Orange LSZH.

Performance

Nexans Category 5e cables are compliant with the requirements of the TIA 568-B and IEC 61156-5.

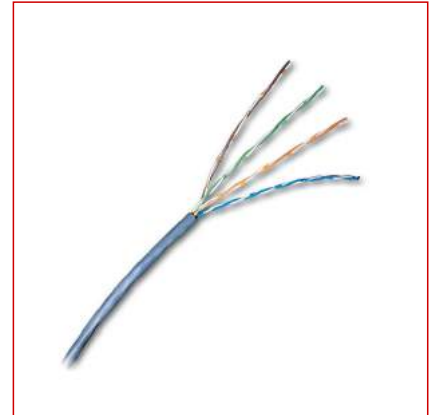

essential

Standards

International ISO/IEC 11801

National TIA/EIA-568-B.2

Essential Cat 5e Cable

Characteristics

Usage characteristics

Range

essential

Product List

☎ = Make to order, 📦 = Make to stock

Nexans ref.	Name	Type of cable	Length (m)	Packaging	Outer sheath
☎ N100.453	Essential F/UTP Cat 5e 0,5MM Dual LSZH 500M REEL	F/UTP Shotgun	500	Reel	LSZH
☎ N100.463	Essential F/UTP Cat 5e 0,5MM Dual PVC 500M REEL	F/UTP Shotgun	500	Reel	PVC
☎ N100.452	Essential F/UTP Cat 5e 0,5MM LSZH 1000M REEL	F/UTP	1000	Reel	LSZH
☎ N100.454	Essential F/UTP Cat 5e 0,5MM LSZH 500M REEL	F/UTP	500	Reel	LSZH
☎ N100.451	Essential F/UTP Cat 5e 0,5MM LSZH BOX 305M	F/UTP	305	Box	LSZH
☎ N100.462	Essential F/UTP Cat 5e 0,5MM PVC 1000M REEL	F/UTP	1000	Reel	PVC
☎ N100.464	Essential F/UTP Cat 5e 0,5MM PVC 500M REEL	F/UTP	500	Reel	PVC
☎ N100.461	Essential F/UTP Cat 5e 0,5MM PVC BOX 305M	F/UTP	305	Box	PVC
☎ N100.410	Essential SF/UTP Cat 5e 0,5MM DUAL LSZH 500M REEL	SF/UTP Shotgun	500	Reel	LSZH
☎ N100.420	Essential SF/UTP Cat 5e 0,5MM DUAL PVC 500M REEL	SF/UTP Shotgun	500	Reel	PVC
☎ N100.407	Essential SF/UTP Cat 5e 0,5MM LSZH 1000M REEL	SF/UTP	1000	Reel	LSZH
☎ N100.471	Essential SF/UTP Cat 5e 0,5MM LSZH 500M REEL	SF/UTP	500	Reel	LSZH
☎ N100.417	Essential SF/UTP Cat 5e 0,5MM PVC 1000M REEL	SF/UTP	1000	Reel	PVC
☎ N100.476	Essential SF/UTP Cat 5e 0,5MM PVC 500M REEL	SF/UTP	500	Reel	PVC
☎ N100.552	Essential U/UTP Cat 5e 0,5MM LSZH 1000M REEL	U/UTP	1000	Reel	LSZH
☎ N100.554	Essential U/UTP Cat 5e 0,5MM LSZH 500M REEL	U/UTP	500	Reel	LSZH
☎ N100.551	Essential U/UTP Cat 5e 0,5MM LSZH BOX 305M	U/UTP	305	Box	LSZH
☎ N100.562	Essential U/UTP Cat 5e 0,5MM PVC 1000M REEL	U/UTP	1000	Reel	PVC
☎ N100.564	Essential U/UTP Cat 5e 0,5MM PVC 500M REEL	U/UTP	500	Reel	PVC
☎ N100.561	Essential U/UTP Cat 5e 0,5MM PVC Box 305M	U/UTP	305	Box	PVC

☎ = Make to order, 📦 = Make to stock

Electrical Performance

all values are specified at 20°C

Frequency	Attenuation dB/100m	NEXT dB	ACR dB/100m	PS NEXT (*) dB	ELFEXT dB/100m	PSELFEXT dB/100m	RL dB
4	4.1	56.3	52.2	53.3	51.7	49.0	23.0
10	6.5	50.3	43.8	47.3	43.8	41.0	25.0
16	8.3	47.2	38.9	44.3	39.7	36.9	25.0
20	9.3	45.8	36.5	42.8	37.7	35.0	25.0
31.25	11.7	42.9	31.2	39.9	33.9	31.1	23.6
62.5	17.0	38.4	21.4	35.4	27.9	25.1	21.5
100	22.0	35.3	13.3	32.3	23.8	21.0	20.1

Essential Cat 5e Cable

(*) Dual cable versions additionally comply to the additional PSNEXT requirements for multi-unit cables as specified in the relevant TIA and IEC cable standards.

Essential Snap-In Connector

- Complies to the latest Category 5e standard
- Fast termination from side or rear
- Fits in all Nexans structural hardware
- 110 and LSA+ termination
- An adaptor can be added to fit the keystone format
- Unscreened or with EMC rear cover

Description

Application

The Nexans Essential Snap-In connector is part of the Nexans modular system and fits in all structural hardware designed for this range. The Nexans Essential Range of Cat 5e cabling products are compliant with ISO/IEC 11801 : 2002.

Installation

The Nexans Essential Snap-in connector is a LSA+/110 connector. It is designed to be terminated by hand, using either 110 or LSA+ termination tool.

- Advantage: 110 and/or LSA+ termination.
- Fast termination of cable from side or rear.
- Colour code: T568A and T568B.
- A clip can be added to adapt for keystone format.
- Fits in all Nexans modular structural hardware of Snap-in.
- Modular patch panel also available.
- Can be used with all types of cables: U/UTP, F/UTP, F2/UTP ,S/FTP or SF/UTP (24 AWG, 23 AWG).
- Can be used with or without an EMC rear cover.
- Two positions for the drain wire connection



essential

Standards

International ISO/IEC 11801

Essential Snap-In Connector

Characteristics



Construction characteristics



Connector type RJ45 and 110/LSA+ IDC

Usage characteristics

Range essential

Product List

Nexans ref.	Name
 N420.426	Essential Screened Snap-In Cat 5e LSA/110 connectivity
 N420.416	Essential Unscreened Snap-In Cat 5e LSA/110 connectivity

 = Make to order,  = Make to stock

Essential-5 Keystone Connector

- Complies with the latest Category 5e standards
- Unscreened
- Fast termination from either side or rear
- Fits in all Nexans keystone hardware designed for Essential-5 and -6
- 110 or LSA+ termination

Description

Application

The Nexans Essential-5 keystone connector is manufactured and tested to the latest Category 5e specifications. It supports Class D applications up to 100 MHz. When installed in conjunction with Essential-5 cable and patch panels, a 25 year Class D Link Warranty can be obtained from the Nexans web site.

Design

The Essential-5 keystone connector is designed to match with Essential-5 cable and patch cords and complements all Essential modular components, such as:

- keystone patch panels (black and white)
- keystone outlet modules (UK, US and European formats)

Please follow the links on this page to view the related datasheets.

The modular jack is designed for keystone footprints of 14.78 mm width, 20-20.78 mm height and 1.5 mm wall thickness and is compatible with a variety of keystone formatted structural hardware. (Please check compatibility with Nexans before using 3rd party hardware)

Performance

The Essential-5 keystone connector is compliant with the specifications of ISO/IEC 11801 and EN 50173.

Installation

- Cable entry from either side or rear.
- Wiring according to colour code T568B or T568A.
- Termination with 110 or LSA+ punchdown tool.
- Accepts 24, 23 and 22 AWG solid core cables.
- Fits Nexans hardware designed for keystone format.



Standards

International ISO/IEC 11801

Contact

LAN Systems (Nexans Cabling Solutions)
 Phone: +44 (0)1256 486640
 ncs.uk@nexans.com

Essential-5 Keystone Connector

Characteristics
Construction characteristics

Connector type RJ45 and 110/LSA+ IDC

Usage characteristics

Range essential

Product List

Nexans ref.	Name
 N420.415 New	Essential-5 Keystone Connector Cat 5e Unscreened

☎ = Make to order,  = Make to stock

Essential Patch Panels

- Complies to the latest Category 5e standard
- Punchdown from the top or the rear side
- Unscreened

Description

Application

The Nexans Essential 1HU twisted pair patch panel is based on 19" frame dimensions. It is easy to manage thanks to the cable guide tie wrap support. The use of patch guides (sold separately) allows an orderly arrangement of patch cords.

Performance

The Nexans Essential Range of Cat 5e cabling products are compliant with ISO/IEC 11801 :2002.

Guarantees

- 20 years link certificate available when installed as part of a Nexans Essential system.

Installation

- Supplied with fixings.
- Unscreened.
- Colour code T568A and T568B (Product dependent).
- Can be used with all types of cables : U/UTP, F/UTP, F2/UTP, S/FTP, SF/UTP (23 AWG , 24 AWG).



Standards

International ISO/IEC 11801

Essential Patch Panels

Product List

☎ = Make to order, 📦 = Make to stock

Nexans ref.	Name
☎ N500.202	Essential 24 port PCB Patch Panel Rear Connection 1 HU Unscreened
☎ N424.510	Essential 24 port PCB Patch Panel Rear Connection Black
☎ N424.513	Essential 24 port PCB Patch Panel Top Connection Black
☎ N424.511	Essential 48 port PCB Patch Panel Rear Connection Black

☎ = Make to order, 📦 = Make to stock

Essential Outlet Modules

- Includes 25x50, LJ6C, and triple modules
- Complies to the latest Category 5e standards
- Unscreened
- LSA+ termination
- UK white
- Fits in all UK Nexans structural hardware

Description

Performance

The Nexans Essential Range of Cat 5e cabling products are compliant with ISO/IEC 11801 : 2002.

Installation

- Supplied with tie wraps
- Unscreened
- Colour code T568B.
- Labelling windows supplied
- LSA + termination
- UK white
- Fits in all UK Nexans structural hardware







essential



Standards

International ISO/IEC 11801

Essential Outlet Modules

Product List

Nexans ref.	Name
 N424.521	25x50 Cat 5e Module
 N424.520	25x50 Cat 5e Module - Low Profile
 N424.523	LJ6C Cat 5e Module
 N424.522	Triple Cat 5e Module
To be removed	

 = Make to order,  = Make to stock

Contact

LAN Systems (Nexans Cabling Solutions)
Phone: +44 (0)1256 486640
ncs.uk@nexans.com

essential patchcords

- Complies to the latest Category 5e standard
- Light grey PVC
- Screened and unshielded
- Moulded strain relief boot

Description

Application

Nexans Essential patch cords are intended to be used to complete the installation of an "Essential" Category 5e system.

- Flexible grey PVC.
- Moulded strain relief boot.
- 1.5m and 3m standard lengths.



essential

Standards

International ISO/IEC 11801





Flame retardant
IEC 60332-1

essential patchcords

Characteristics

Construction characteristics	
Outer sheath	PVC
Colour	Grey
Electrical characteristics	
Characteristic impedance	100 Ohm
Usage characteristics	
Mechanical durability/matings	100
Range	essential
Flame retardant	IEC 60332-1
Category	Cat. 5e

Product List

Nexans ref.	Name	Screen	Length (m)
 N101.122DGG	Essential Patch Cord F/UTP Cat 5 1,5m PVC grey	Yes	1.5
 N101.122FGG	Essential Patch Cord F/UTP Cat 5 3m PVC grey	Yes	3
 N101.112DGG	Essential Patch Cord U/UTP Cat 5 1,5m PVC grey	No	1.5
 N101.112FGG	Essential Patch Cord U/UTP Cat 5 3m PVC grey	No	3

☎ = Make to order,  = Make to stock

Category 6 / 6A

LANmark-6 is considered the best horizontal solution for most enterprise requirements by combining high performance for today, room for growth tomorrow, and high reliability and efficiency. The range of systems include 10Gigabit solutions offering bandwidth up to 500MHz with extensive headroom on channel performance. Recommended uses:

- Typical 5-10 year building life
- Typical enterprise applications - Fast Ethernet & Gigabit Ethernet
- 10Gigabit variants for high data environments and datacentres
- Where reliability is considered vital for business
- Typical office or indoor light industrial environments

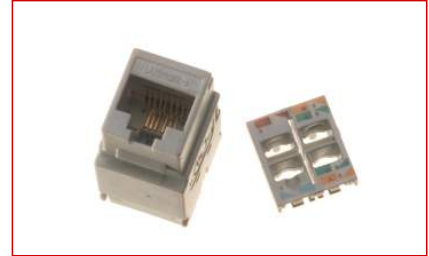

Contact

LAN Systems (Nexans Cabling Solutions)
Phone: +44 (0)1256 486640
ncs.uk@nexans.com

LANmark-6 Cable

- Complies to all Category 6 cable standards
- Supports Class E applications
- Central cross member maintains geometry and performance
- Tested up to 350MHz

Description

Application

LANmark-6 cable is the ultimate solution for a future proof network. It is specifically designed to support the exacting requirements for tomorrow's protocols, yet is fully backwards compatible with today's needs. It is the recommended cable for all forthcoming installations.

- 10baseT Ethernet
- 100baseTX Fast Ethernet
- 1000baseTX Gigabit Ethernet
- 155 MBit ATM
- 622 MBit ATM
- 1.2 Gbit ATM
- Future class E applications

LANmark-6 is independently verified to exceed the requirements of the ISO/IEC 11801:2002 Category 6 requirements.

Performance

Tested to 350 MHz and with guaranteed performance to 250 MHz, Nexans LANmark-6 cables provide guaranteed headroom and bandwidth over and above the requirements of all international, european and american cable standards, including ISO/IEC 11801:2002, IEC 61156-5, EN 50173, EN 50288, TIA/EIA 568-B.2-1.

Installation

LANmark-6 is installed in exactly the same way as Category 5 cables. The C³ central cross member reduces the risk of crushing and kinking.

Guarantees

Nexans LANmark-6 cable is covered by the guarantee that it is Category 6 and by a parts and labour warranty as described in the Nexans Certified System Warranty.



LANmark-6

Standards

International EN 50288;
IEC 61156-5; ISO/IEC 11801
National TIA/EIA-568-B.2-1

LANmark-6 Cable

Product List

☎ = Make to order, 📦 = Make to stock

Nexans ref.	Name	Type of cable	Category	Outer sheath	Conductor cross-section (AWG)
📦 N100.623	LANmark-6 F1/UTP Dual LSZH 500m reel	FTP Shotgun	Cat. 6	LSZH	24
📦 N100.628	LANmark-6 F1/UTP Dual PVC 500m reel	FTP Shotgun	Cat. 6	PVC	24
📦 N100.622	LANmark-6 F1/UTP LSZH 1000m reel	F/UTP	Cat. 6	LSZH	24
📦 N100.624	LANmark-6 F1/UTP LSZH 500m reel	F/UTP	Cat. 6	LSZH	24
📦 N100.627	LANmark-6 F1/UTP PVC 1000m reel	F/UTP	Cat. 6	PVC	24
📦 N100.629	LANmark-6 F1/UTP PVC 500m reel	F/UTP	Cat. 6	PVC	24
📦 N100.603	LANmark-6 F ² /UTP Dual LSZH 500m reel	F ² TP Shotgun	Cat. 6	LSZH	24
📦 N100.613	LANmark-6 F ² /UTP Dual PVC 500m reel	F ² TP Shotgun	Cat. 6	PVC	24
📦 N100.601	LANmark-6 F ² /UTP LSZH 1000m reel	F ² TP	Cat. 6	LSZH	24
📦 N100.662	LANmark-6 F ² /UTP LSZH 500m reel	F ² TP	Cat. 6	LSZH	24
📦 N100.611	LANmark-6 F ² /UTP PVC 1000m reel	F ² TP	Cat. 6	PVC	24
📦 N100.661	LANmark-6 F ² /UTP PVC 500m reel	F ² TP	Cat. 6	PVC	24
☎ N100.633	LANmark-6 SF/UTP Dual LSZH 500m reel	SF/UTP Shotgun	Cat. 6	LSZH	23
☎ N100.631	LANmark-6 SF/UTP LSZH 1000m reel	SF/UTP	Cat. 6	LSZH	23
📦 N100.632	LANmark-6 SF/UTP LSZH 500m reel	SF/UTP	Cat. 6	LSZH	23
📦 N100.609	LANmark-6 U/UTP Dual LSZH 500m reel	U/UTP	Cat. 6	LSZH	23
📦 N100.619	LANmark-6 U/UTP Dual PVC 500m reel	U/UTP	Cat. 6	PVC	23
📦 N100.606	LANmark-6 U/UTP LSZH 1000m reel	U/UTP	Cat. 6	LSZH	23
📦 N100.607	LANmark-6 U/UTP LSZH 305m Box	U/UTP	Cat. 6	LSZH	23
📦 N100.605	LANmark-6 U/UTP LSZH 500m reel	U/UTP	Cat. 6	LSZH	23
📦 N100.616	LANmark-6 U/UTP PVC 1000m reel	U/UTP	Cat. 6	PVC	23
📦 N100.617	LANmark-6 U/UTP PVC 305m Box	U/UTP	Cat. 6	PVC	23
📦 N100.608	LANmark-6 U/UTP PVC 500m reel	U/UTP	Cat. 6	PVC	23

☎ = Make to order, 📦 = Make to stock

LANmark-6 Cable

Electrical Performance

All values are specified at 20°C

Frequency	Attenuation dB/100m	NEXT dB	ACR dB/100m	PSNEXT(*) dB	ELFEXT dB/100m	PSELFEXT dB/100m	RL dB
1	2.0	74.3	72.3	72.3	70.0	67.0	20.0
4	3.8	65.3	61.5	63.3	58.0	55.0	23.0
10	6.0	59.3	53.3	57.3	50.0	47.0	25.0
16	7.6	56.2	48.6	54.3	45.9	42.9	25.0
20	8.5	54.8	46.3	52.8	44.0	41.0	25.0
31.25	10.7	51.9	41.2	49.9	40.5	37.5	23.6
62.5	15.4	47.4	32.0	45.4	34.1	31.1	21.5
100	19.8	44.3	24.5	42.3	30.0	27.0	20.1
155	25.2	41.4	16.2	39.5	26.2	23.2	18.8
200	29.0	39.8	10.8	37.8	24.0	21.0	18.0
250	32.8	38.3	5.5	36.3	22.0	19.0	17.3
300	36.4	37.1	1.5	35.2	20.5	17.5	16.8
350	39.8	36.1	-	34.2	19.1	16.1	14.1

(*) Dual cable versions additionally comply to the additional PSNEXT requirements for multi-unit cables as specified in the relevant TIA and IEC cable standards.

LANmark-6 Snap-In Connector

- Cat 6 Snap-In available in 3 versions UTP, FTP, EMC.
- Fits in all structural hardware designed for this range.
- Easy termination, without punch down tool.
- An adapter can be added to fit the keystone format

Description

Application

The LANmark-6 Toolless Snap-In Connector is part of the Nexans modular system and fits in all structural hardware designed for this range. As such it supports all data applications defined for Cat 5, Cat 5e and Cat 6, such as 10baseT, Fast Ethernet, Gigabit Ethernet, 155 ATM, 622 ATM, 1.2 ATM...

Performance

The LANmark-6 Snap-In Connector has been designed to reach the highest performance in Cat 6 and Class E. It has outstanding performance for attenuation (insertion loss), NEXT/FEXT, Power Sum NEXT/FEXT and Return Loss, exceeding the Cat 6 connector specs as in ISO/IEC 11801:2002. The unique cross-technology in the connector ensures the high performance of the link. Used with Nexans LANmark-6 cables and patchcords, the connector is independently tested to exceed the link and stringent four-connector channel requirements as defined in the ISO/IEC 11801:2002.

Guarantees

The LANmark-6 Snap-In Connector is covered by the guarantee as in 'The General Terms and Conditions of Sales'. In combination with the Nexans LANmark-6 product range, the Nexans Certified System Warranty can be obtained, covering parts, system and labour warranty.

Installation

The LANmark-6 Snap-In Connector is a toolless connector. It is designed to be terminated by hand, without punchdown tool. For faster and easier installation of large volumes, an optional comfort tool can be used.

- Fast termination of cable
- Colour code : TSB568A & TSB568B
- Can be used with all types of cables : F²TP, UTP or STP
- Accepts 24, 23 and 22 AWG cable

**LANmark-6**

Standards

International ISO/IEC 11801

LANmark-6 Snap-In Connector



Characteristics





Usage characteristics



Category

Cat. 6

Product List

 = Make to order,  = Make to stock

Nexans ref.	Name	Height (mm)	Width (mm)	Range
 N420.666 New	LANmark-6 EVO Snap- in connector, Toolless connectivity, screened, with rear cover (EMC) for solid wire	23.2	16.8	LANmark-6
 N420.667 New	LANmark-6 EVO Snap-in connector, Toolless connectivity, screened, with rear cover (EMC) for stranded wire	23.2	16.8	LANmark-6
 N420.660 New	LANmark-6 EVO Snap-in connector, Toolless connectivity, unscreened for solid wire	22.9	16.7	LANmark-6
 N420.661 New	LANmark-6 EVO Snap-in connector, Toolless connectivity, unscreened for stranded wire	22.9	16.7	LANmark-6

 = Make to order,  = Make to stock

Electrical Performance

Frequency MHz	Attenuation	NEXT pp	PSNEXT	FEXT pp	PSFEXT	RL
1	0.1	94.0	90.0	83.1	80.1	30.0
4	0.1	82.0	78.0	71.1	68.1	30.0
10	0.1	74.0	70.0	63.1	60.1	30.0
16	0.1	69.9	65.9	59.0	56.0	30.0
20	0.1	68.0	64.0	57.1	54.1	30.0
31.25	0.1	64.1	60.1	53.2	50.2	30.0
62.5	0.2	58.1	54.1	47.2	44.2	28.1
100	0.2	54.0	50.0	43.1	40.1	24.0
125	0.2	52.1	48.1	41.2	38.2	22.1
155	0.2	50.2	46.2	39.3	36.3	20.2
175	0.3	49.1	45.1	38.2	35.2	19.1
200	0.3	48.0	44.0	37.1	34.1	18.0
250	0.3	46.0	42.0	35.1	32.1	16.0

All values are in dB

LANmark-6 UniBoot Patch Cords

- Complies fully with Category 6 standards
- Uses Nexans cable technology
- Fully matched with other components for maximum performance
- LSZH Flame retardant jacket
- Retrofit Latch Protector available in 8 colours for colour coding

Description

Application

LANmark-6 Patch Cords can be used to deliver a full end-to-end Class E solution.

They provide improved data throughput and allow for the inclusion of a cross-connect or Consolidation Points for maximum system flexibility. They will also maximise the lifetime and long term performance of the system by minimising the risk of wear & tear damage which can be caused by using non-matched cords. .

LANmark-6 Cords feature a slim over-moulded boot which is kept inside the RJ45 boundaries to enable High Density Patching with 48 cords in 1 height unit. They also come with a Retrofit Latch Protector, which can be used for colour coding of different services.

Guarantees

When installed in combination with other LANmark-6 components, a 25 years channel warranty can be obtained, covering full Cat 6/Class E compliance.

Installation

- Small cross section allows neat installation and simplifies the creation of bundles in cabinets.
- A Low Smoke Zero Halogen - Flame Retardant jacket is standard.
- 1, 2, 3, 5, 10 and 20m are standard lengths; other lengths are available on demand.
- Orange and Dark Grey are standard colours available from stock; other colours are available on demand.
- Default Plug configuration is a black boot with a preinstalled black latch protector; other combinations available on request.



LANmark-6

Standards

International EN 50173 Ed.1; ISO/IEC 11801

National TIA/EIA-568-B.2-1

LANmark-6 UniBoot Patch Cords

Product List

☎ = Make to order, 📦 = Make to stock

Nexans ref.	Name	Range	Colour	Screen	Length (m)
 N116.P1A100DK New	LANmark-6 Patch Cord Cat 6 Unscreened LSZH 10m Grey	LANmark-6	Grey	No	10
 N116.P1A100OK New	LANmark-6 Patch Cord Cat 6 Unscreened LSZH 10m Orange	LANmark-6	Orange	No	10
 N116.P1A010DK New	LANmark-6 Patch Cord Cat 6 Unscreened LSZH 1m Grey	LANmark-6	Grey	No	1
 N116.P1A010OK New	LANmark-6 Patch Cord Cat 6 Unscreened LSZH 1m Orange	LANmark-6	Orange	No	1
 N116.P1A200DK New	LANmark-6 Patch Cord Cat 6 Unscreened LSZH 20m Grey	LANmark-6	Grey	No	20
 N116.P1A200OK New	LANmark-6 Patch Cord Cat 6 Unscreened LSZH 20m Orange	LANmark-6	Orange	No	20
 N116.P1A020DK New	LANmark-6 Patch Cord Cat 6 Unscreened LSZH 2m Grey	LANmark-6	Grey	No	2
 N116.P1A020OK New	LANmark-6 Patch Cord Cat 6 Unscreened LSZH 2m Orange	LANmark-6	Orange	No	2
 N116.P1A030DK New	LANmark-6 Patch Cord Cat 6 Unscreened LSZH 3m Grey	LANmark-6	Grey	No	3
 N116.P1A030OK New	LANmark-6 Patch Cord Cat 6 Unscreened LSZH 3m Orange	LANmark-6	Orange	No	3
 N116.P1A050DK New	LANmark-6 Patch Cord Cat 6 Unscreened LSZH 5m Grey	LANmark-6	Grey	No	5
 N116.P1A050OK New	LANmark-6 Patch Cord Cat 6 Unscreened LSZH 5m Orange	LANmark-6	Orange	No	5

☎ = Make to order, 📦 = Make to stock

LANmark-6 10G UniBoot Patch Cords

- High speed RJ45 patch cord to run 10GBase-T (IEEE 802.3an)
- High Density support : 48 cords on 1 height unit
- Frequency up to 500MHz, fully complies to Cat 6A channel requirements
- Screened Design for Alien Crosstalk immunity
- Externally certified
- Retrofit Latch Protector available in 6 colors for color coding

Description

Application

LANmark-6 10G Cords are developed to support 10 Gigabit Ethernet (IEEE 802.3an).

LANmark-6 10G Cords offer superior performance up to 500MHz and are matched with other LANmark-6 10G components to provide improved data throughput in complex channel configurations. LANmark-6 10G Cords use stranded cable and as such provide maximum system flexibility for the use at Cross Connects and Consolidation points.

LANmark-6 10G Cords feature a robust boot which does not extend outside the RJ45 boundaries to enable High Density Patching with 48 cords in 1 height unit and an Retrofit Latch Protector, which can be used for color coding of different services.

Performance

LANmark-6 10G Cords fully comply and exceed the channel requirements of EIA/TIA-568-B.2-10 and ISO11801 A2 and enable to achieve high performing 10G channels.

Guarantees

When installed in combination with other LANmark-6 10G components, a 25 years channel warranty can be obtained, covering full 10GBase-T support and full Cat 6A/Class EA compliance.

Usage

- The cords are by design fully Alien Crosstalk compliant, so no special installation rules need to be taken into account for ANEXT and AFEXT compliance.
- 1, 2, 3, 5, 10, 20m are standard lengths available from stock, other lengths are available on demand.
- Orange and Dark Grey are standard colours available from stock, other colours are available on demand.
- Default Plug configuration is a black boot with a preinstalled black latch protector, other combinations available on request.



LANmark-6 10G

Standards













International IEEE 802.3an; ISO/IEC TR24750; ISO11801:2002/A1:2008

National TIA/EIA TSB-155; TIA/EIA-568-B.2-10

LANmark-6 10G UniBoot Patch Cords

Product List

☎ = Make to order, 📦 = Make to stock

Nexans ref.	Name	Range	Length (m)	Colour	Screen
 N11G.P1B100DK New	LANmark-6 10G Patch Cord Cat 6 500MHz Screened LSZH 10m Grey	LANmark-6 10G	10	Grey	Yes
 N11G.P1B100OK New	LANmark-6 10G Patch Cord Cat 6 500MHz Screened LSZH 10m Orange	LANmark-6 10G	10	Orange	Yes
 N11G.P1B010DK New	LANmark-6 10G Patch Cord Cat 6 500MHz Screened LSZH 1m Grey	LANmark-6 10G	1	Grey	Yes
 New	LANmark-6 10G Patch Cord Cat 6 500MHz Screened LSZH 1m Orange	LANmark-6 10G	1	Orange	Yes
 N11G.P1B010OK New	LANmark-6 10G Patch Cord Cat 6 500MHz Screened LSZH 1m Orange	LANmark-6 10G	1	Orange	Yes
 N11G.P1B200DK New	LANmark-6 10G Patch Cord Cat 6 500MHz Screened LSZH 20m Grey	LANmark-6 10G	20	Grey	Yes
 N11G.P1B200OK New	LANmark-6 10G Patch Cord Cat 6 500MHz Screened LSZH 20m Orange	LANmark-6 10G	20	Orange	Yes
 N11G.P1B020DK New	LANmark-6 10G Patch Cord Cat 6 500MHz Screened LSZH 2m Grey	LANmark-6 10G	2	Grey	Yes
 N11G.P1B020OK New	LANmark-6 10G Patch Cord Cat 6 500MHz Screened LSZH 2m Orange	LANmark-6 10G	2	Orange	Yes
 N11G.P1B030DK New	LANmark-6 10G Patch Cord Cat 6 500MHz Screened LSZH 3m Grey	LANmark-6 10G	3	Grey	Yes
 N11G.P1B030OK New	LANmark-6 10G Patch Cord Cat 6 500MHz Screened LSZH 3m Orange	LANmark-6 10G	3	Orange	Yes
 N11G.P1B050DK New	LANmark-6 10G Patch Cord Cat 6 500MHz Screened LSZH 5m Grey	LANmark-6 10G	5	Grey	Yes
 N11G.P1B050OK New	LANmark-6 10G Patch Cord Cat 6 500MHz Screened LSZH 5m Orange	LANmark-6 10G	5	Orange	Yes

☎ = Make to order, 📦 = Make to stock

Electrical Performance LANmark-6 10G 100m 4 connector channel

all values are specified at 20°C

Freq	Attn dB		NEXT dB		PSNEXT dB		ELFEXT dB		PS ELFEXT dB		PS ANEXT dB		PS AELFEXT dB		RL dB	
	Std	Guar	Std	Guar	Std	Guar	Std	Guar	Std	Guar	Std	Guar	Std	Guar	Std	Guar
1	<4	<4	72.7	>75	70.3	74.3	63.3	>60	60.3	>60	82.0	>90	77.9	87.9	19.0	21.0
4	4.2	4.1	63.0	66.0	60.5	64.5	51.2	57.2	48.2	57.2	76.0	>90	65.9	75.9	19.0	21.0
10	6.6	6.5	56.6	59.6	54.0	58.0	43.3	49.3	40.3	49.3	72.0	87.0	57.9	67.9	19.0	21.0
16	8.3	8.2	53.2	56.2	50.6	54.6	39.2	45.2	36.2	45.2	70.0	85.0	53.8	63.8	18.0	20.0
20	9.3	9.2	51.6	54.6	49.0	53.0	37.2	43.2	34.2	43.2	69.0	84.0	51.9	61.9	17.5	19.5
31.25	11.7	11.6	48.4	51.4	45.7	49.7	33.4	39.4	30.4	39.4	67.1	82.1	48.0	58.0	16.5	18.5
62.5	16.9	16.6	43.4	46.4	40.6	44.6	27.3	33.3	24.3	33.3	64.0	79.0	42.0	52.0	14.0	16.0
100	21.7	21.4	39.9	42.9	37.1	41.1	23.3	29.3	20.3	29.3	62.0	77.0	37.9	47.9	12.0	14.0
155	27.6	27.1	36.7	39.7	33.8	37.8	19.5	25.5	16.5	25.5	59.1	74.1	34.1	44.1	10.1	12.1
200	31.7	31.2	34.8	37.8	31.9	35.9	17.2	23.2	14.2	23.2	57.5	72.5	31.9	41.9	9.0	11.0
250	35.9	35.4	33.1	36.1	30.2	34.2	15.3	21.3	12.3	21.3	56.0	71.0	29.9	39.9	8.0	10.0
300	39.8	39.2	31.7	34.7	28.8	32.8	13.7	19.7	10.7	19.7	54.8	69.8	28.4	38.4	7.2	9.2
500	53.4	52.6	22.0	25.0	20.4	24.4	9.3	15.3	6.3	15.3	51.5	66.5	23.9	33.9	6.0	8.0

Guaranteed channel values apply under the condition that General Installation Guidelines from NCS and the Design and Installation Guidelines for LANmark-6 10G are respected and implemented.

LANmark-6 10G Snap-In Connector

- Complies to 10GBase-T application standards
- Complies with Category 6A and Class EA channel requirements
- Fully screened for alien crosstalk immunity
- Reduces risk of installation errors for consistent performance
- Compatible with all snap-in hardware
- An adapter can be added to fit the keystone format

Description

Application

LANmark-6 10G consists of screened components specified to frequencies up to 500MHz. They have been designed specifically to support the higher frequencies required for 10 Gigabit Ethernet, yet is fully backwards compatible with today's needs. The LANmark-6 10G EVO connector fits in all structural hardware designed for the EVO snap-in range. In addition to the requirements of the EIA/TIA 568-B.2-1 and ISO/IEC 11801:2002 Category 6, the LANmark-6 10G products are additionally specified to 500MHz and are screened to ensure immunity from Alien Crosstalk and other external interference.

- 10Base-T Ethernet
- 100Base-TX Fast Ethernet
- 1000Base-TX Gigabit Ethernet
- 10GBase-T 10 Gigabit Ethernet IEEE 802.3
- 155 Mbit ATM
- 1.2 Gbit ATM
- future class E 10G applications

Performance

The LANmark-6 10G EVO Snap-in connector has been designed to reach the highest performance in Cat 6 and Class E up to 500 MHz. It has outstanding performance for attenuation (insertion loss), NEXT/FEXT, Power Sum NEXT/FEXT and Return Loss, exceeding the Cat 6 connector specs as in IEC 60603-7-5.

When used in combination with Nexans LANmark-6 10G cables and LANmark-6 10G Ultim patch cords, and installed according to the guidelines, the system supports the 10GBase-T applications as defined in IEEE 802.3an, ISO/IEC TR 24750 and TIA/EIA TSB-155. Respecting the Nexans LANmark-6 10G design guidelines, the full 100m four-connector channel moreover meets Category 6A and Class EA requirements as defined in TIA/EIA568B.2 Addendum 10 draft 6.0 and ISO/IEC draft amendment 1.1 (as in draft 25N1324) respectively.

Installation

The LANmark-6 10G EVO Snap-in connector makes termination easier and quicker thanks to exclusive design of the wire organizer and of the sliding metal EMC rear cover. The LANmark-6 10G EVO snap-in is designed to be terminated with the universal comfort tool. This tool includes also the exclusive extraction mechanism which makes the EVO series snap-in re-usable. A stranded version is available for reliable termination in consolidation point of 3 or 4 connectors channel models. The LANmark-6 10G EVO snap-in range is Nexans technology inside and user friendly outside



LANmark-6 10G

Standards

International IEEE 802.3an; ISO/IEC TR24750; ISO11801:2002/A1:2008

National TIA/EIA TSB-155; TIA/EIA-568-B.2-10

LANmark-6 10G Snap-In Connector

- Fast termination with exclusive wire organizer and sliding metal EMC rear cover
- Colour code : T568A & T568B
- Full EMC protection with metal rear cover
- Re-usable with universal comfort tool
- Accepts solid wire from 22 to 24 AWG
- Stranded version available for consolidation point
- Snap-in format fits in all Nexans structural hardware
- 2 possibilities to terminate the drain wire : on the housing or on the rear cover

Guarantees

The LANmark-6 10G EVO Snap-in connector is covered by the guarantee as in The General Terms and Conditions of Sales. When installed in combination with other LANmark-6 10G components, a 25 years channel warranty can be obtained, covering 10GBase-T support in accordance with IEEE 802.3an. Also if following the design guidelines for LANmark-6 10G systems and tested accordingly, a 25 year warranty can be obtained to Category 6A or Class EA requirements.

LANmark-6 10G Snap-In Connector



Characteristics

Usage characteristics

Range

LANmark-6 10G

Product List

Nexans ref.	Name
 N420.666G New	LANmark-6 10G EVO Snap-in connector, screened, for solid wire
 N420.667G New	LANmark-6 10G EVO Snap-in connector, screened, for stranded wire

☎ = Make to order,  = Make to stock

Electrical Performance LANmark-6 10G 100m 4 connector channel

all values are specified at 20°C

Freq	Attn dB		NEXT dB		PSNEXT dB		ELFEXT dB		PS ELFEXT dB		PS ANEXT dB		PS AELFEXT dB		RL dB	
	Std	Guar	Std	Guar	Std	Guar	Std	Guar	Std	Guar	Std	Guar	Std	Guar	Std	Guar
1	<4	<4	72.7	>75	70.3	74.3	63.3	>60	60.3	>60	82.0	>90	77.9	87.9	19.0	21.0
4	4.2	4.1	63.0	66.0	60.5	64.5	51.2	57.2	48.2	57.2	76.0	>90	65.9	75.9	19.0	21.0
10	6.6	6.5	56.6	59.6	54.0	58.0	43.3	49.3	40.3	49.3	72.0	87.0	57.9	67.9	19.0	21.0
16	8.3	8.2	53.2	56.2	50.6	54.6	39.2	45.2	36.2	45.2	70.0	85.0	53.8	63.8	18.0	20.0
20	9.3	9.2	51.6	54.6	49.0	53.0	37.2	43.2	34.2	43.2	69.0	84.0	51.9	61.9	17.5	19.5
31.25	11.7	11.6	48.4	51.4	45.7	49.7	33.4	39.4	30.4	39.4	67.1	82.1	48.0	58.0	16.5	18.5
62.5	16.9	16.6	43.4	46.4	40.6	44.6	27.3	33.3	24.3	33.3	64.0	79.0	42.0	52.0	14.0	16.0
100	21.7	21.4	39.9	42.9	37.1	41.1	23.3	29.3	20.3	29.3	62.0	77.0	37.9	47.9	12.0	14.0
155	27.6	27.1	36.7	39.7	33.8	37.8	19.5	25.5	16.5	25.5	59.1	74.1	34.1	44.1	10.1	12.1
200	31.7	31.2	34.8	37.8	31.9	35.9	17.2	23.2	14.2	23.2	57.5	72.5	31.9	41.9	9.0	11.0
250	35.9	35.4	33.1	36.1	30.2	34.2	15.3	21.3	12.3	21.3	56.0	71.0	29.9	39.9	8.0	10.0
300	39.8	39.2	31.7	34.7	28.8	32.8	13.7	19.7	10.7	19.7	54.8	69.8	28.4	38.4	7.2	9.2
500	53.4	52.6	22.0	25.0	20.4	24.4	9.3	15.3	6.3	15.3	51.5	66.5	23.9	33.9	6.0	8.0

Guaranteed channel values apply under the condition that General Installation Guidelines from NCS and the Design and Installation Guidelines for LANmark-6 10G are respected and implemented.

LANmark-6A Cable

- Ideal Cable for 10GBase-T application
- Complies fully with new standards for Category 6A and Class EA
- Small diameter
- Guaranteed performance up to 500MHz
- Fully screened for alien crosstalk immunity

Description

Application

LANmark-6A cable is the ideal solution for a 10 Gigabit Ethernet network. The range consists of cables which have been designed specifically to support the higher frequencies required for 10 Gigabit Ethernet, while maintain to be fully backwards compatible with today's needs. All LANmark-6A products are screened cables to ensure immunity from Alien Crosstalk and other external interference and are specified up to frequencies of 500MHz.

- 10Base-T Ethernet
- 100Base-TX Fast Ethernet
- 1000Base-TX Gigabit Ethernet
- 10GBase-T 10 Gigabit Ethernet IEEE 802.3
- 155 Mbit ATM
- 1.2 Gbit ATM
- future Cat 6A and Class EA applications

Performance

With guaranteed performance to 500MHz, Nexans LANmark-6A cables provide guaranteed headroom and bandwidth over and above the Category 6A requirements of international, european and american cable standards, including of IEC 61156-5, EN 50173, EN 50288, TIA/EIA 568-B.2-1 Ad.10. When used in combination with Nexans LANmark-6A Evo connectors and LANmark-6A Ultim patch cords, the system supports the 10GBase-T applications as defined in IEEE 802.3an, and the full 100m four-conductor links and channels meet Category 6A and Class EA requirements as defined in TIA/EIA568B.2 Addendum 10 and ISO/IEC11801 2002/A1:2008.

Installation

The LANmark-6A cables have the advantage of offering equal dimensions and flexibility as the equivalent LANmark-6 screened cables with the same ease of installation and termination.

Guarantees

Nexans LANmark-6A 10G cable is covered by a parts and labour warranty as described in the Nexans Certified System Warranty. When installed in combination with other LANmark-6A 10G components, a 25 year channel warranty can be obtained.



LANmark-6A

Standards

International EN 50288-4-1;
IEC 61156-5; IEEE 802.3an; ISO/
IEC 11801:2002/A2:2008; ISO/
IEC 24764; ISO/IEC TR24750;
ISO11801:2002/A1:2008

National ANSI/TIA-568-C.2; TIA/
EIA TSB-155

LANmark-6A Cable

Product List

☞ = Make to order, ☐ = Make to stock

Nexans ref.	Name	Outer sheath
☐ N100.693G	LANmark-6A F/FTP Cat 6A 500MHz Dual LSZH 500m reel	LSZH
☞ N100.698G	LANmark-6A F/FTP Cat 6A 500MHz Dual PVC 500m reel	PVC
☐ N100.692G	LANmark-6A F/FTP Cat 6A 500MHz LSZH 1000m reel	LSZH
☐ N100.694G	LANmark-6A F/FTP Cat 6A 500MHz LSZH 500m reel	LSZH
☞ N100.697G	LANmark-6A F/FTP Cat 6A 500MHz PVC 1000m reel	PVC
☞ N100.699G	LANmark-6A F/FTP Cat 6A 500MHz PVC 500m reel	PVC
☐ N100.623G	LANmark-6A F1/UTP Cat 6A 500MHz Dual LSZH 500m reel	LSZH
☐ N100.622G	LANmark-6A F1/UTP Cat 6A 500MHz LSZH 1000m reel	LSZH
☐ N100.624G	LANmark-6A F1/UTP Cat 6A 500MHz LSZH 500m reel	LSZH

☞ = Make to order, ☐ = Make to stock

Electrical Performance LANmark-6A 10G F1UTP cable

Freq in MHz	Attn in dB		NEXT in dB		PSNEXT in dB		ACR-F in dB		PS ACR-F in dB		PS ANEXT in dB		PS AACR-F in dB		RL in dB	
	Max.	Typ.	Min.	Typ.	Min.	Typ.	Min.	Typ.	Min.	Typ.	Min.	Typ.	Min.	Typ.	Min.	Typ.
1	2.1	2.1	74.3	79.3	72.3	77.3	67.8	92.8	64.8	>60	67.0	90.0	67.0	87.9	20.0	26.0
4	3.8	3.8	65.3	70.3	63.3	68.3	55.8	80.8	52.8	57.2	67.0	90.0	66.2	75.9	23.0	29.0
10	5.9	5.9	59.3	64.3	57.3	62.3	47.8	72.8	44.8	49.3	67.0	87.0	58.2	67.9	25.0	31.0
16	7.5	7.5	56.2	61.2	54.2	59.2	43.7	68.7	40.7	45.2	67.0	85.0	54.1	63.8	25.0	31.0
20	8.4	8.4	54.8	59.8	52.8	57.8	41.8	66.8	38.8	43.2	67.0	84.0	52.2	61.9	25.0	31.0
31.25	10.5	10.5	51.9	56.9	49.9	54.9	37.9	62.9	34.9	39.4	67.0	82.1	48.3	58.0	23.6	29.6
62.5	15.0	15.0	47.4	52.4	45.4	50.4	31.9	56.9	28.9	33.3	65.6	79.0	42.3	52.0	21.5	27.5
100	19.1	19.1	44.3	49.3	42.3	47.3	27.8	52.8	24.8	29.3	62.5	77.0	38.2	47.9	20.1	26.1
155	24.1	24.1	41.4	46.4	39.4	44.4	24.0	49.0	21.0	25.5	59.6	74.1	34.4	44.1	18.8	24.8
200	27.6	27.6	39.8	44.8	37.8	42.8	21.8	46.8	18.8	23.2	58.0	72.5	32.2	41.9	18.0	24.0
250	31.1	31.1	38.3	43.3	36.3	41.3	19.8	44.8	16.8	21.3	56.5	71.0	30.2	39.9	17.3	23.3
300	34.3	34.3	37.1	42.1	35.1	40.1	18.3	43.3	15.3	19.7	55.3	69.8	28.7	38.4	16.8	22.8
500	45.3	45.3	33.8	38.8	31.8	36.8	13.8	38.8	10.8	15.3	52.0	66.5	24.2	33.9	15.2	21.2

all values are specified at 20°C

LANmark-6A Connector

- High bandwidth RJ45 connector to support 10Gigabit Ethernet
- Fully complies to TIA and ISO Cat 6A cabling standards
- Supports extremely short Cat 6A channel configurations needed for datacenters
- Fully screened for alien crosstalk immunity
- Compatible with all Snap-In panels and outlets

Description

Application

LANmark-6A EVO Snap-In Connector is a screened RJ45 cable jack specified up to 500MHz. It is designed specifically to support the high frequencies required for 10 Gigabit Ethernet, but is also fully backwards-compatible with lower frequency applications using the RJ45 interface. LANmark-6A EVO uses a fully closed rear cover, which provides 360° screening and excellent coupling attenuation to ensure immunity from alien crosstalk and other external interference. Cabling channels with LANmark-6A cable jack have not to be verified on site for Alien Crosstalk, as this new 10G parameter is met by design. This reduces significantly the cost for 10G networking.

- 10Base-T Ethernet
- 100Base-TX Fast Ethernet
- 1000Base-TX Gigabit Ethernet
- 10GBase-T 10 Gigabit Ethernet IEEE 802.3
- 155 Mbit ATM
- 1.2 Gbit ATM
- all future Cat 6A and Class EA applications

Performance

The LANmark-6A EVO has outstanding electrical performance up to 500MHz especially for NEXT/FEXT, Power Sum NEXT/FEXT, Return Loss and all screening parameters. This enables to achieve high performing Cat 6A channels as well as very short link and channel configurations needed in data centres with up to 3 connection points within 12 meters.

Installation

LANmark-6A EVO makes use of Nexans wire organiser and is therefore very easy and fast to terminate. Using the Nexans comfort tool installation tool EVO Snap-In series is re-usable. A stranded version is available to allow the use of flexible stranded cable in cross connects or consolidation point.

The LANmark-6A EVO fits in all structural hardware designed for the EVO Snap-In range and can be used in all positions of a 4 connector twisted pair cabling channel (PP, CC, CP, TO).

- Fast termination with exclusive wire organizer and hinging metal EMC rear cover
- Colour code : T568A & T568B
- 360° EMC protection
- Re-usable with universal comfort tool
- Accepts solid wire from 22 to 24 AWG
- Stranded version available for consolidation point
- Snap-in format fits in all Nexans structural hardware
- 2 possibilities to terminate the drain wire : on the housing or on the rear cover
- Can be turned into keystone format using an additional adapter

Guarantees

When installed in combination with other LANmark-6A components, a 25 years channel warranty can be obtained, covering full 10GBase-T support and full Cat 6A/Class EA compliance

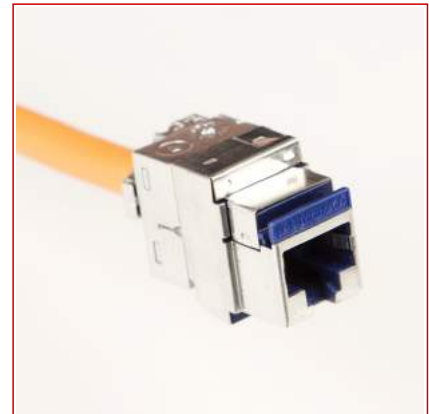

LANmark-6A



Standards



International EN 50173-1;
 EN 50173-3; IEC 60603-7-5;
 IEC 60603-7-51; ISO/
 IEC 11801:2002/A2:2008; ISO/
 IEC 24764; ISO11801:2002/A1:2008

National ANSI/TIA-568-C.2

LANmark-6A Connector

Product List

Nexans ref.	Name
 N420.66A New	LANmark-6A Snap-In Connector Cat 6A 500MHz Screened
 N420.67A New	LANmark-6A Snap-In Connector Cat 6A 500MHz Screened for stranded wire

 = Make to order,  = Make to stock

LANmark-6A Connector

Electrical Performance LANmark-6A 4 Connector Channel Part 1

"All values are based on Worst Case 4 Connector Channel configurations according ISO11801:2008 AM1 Minimal and maximum values represent guaranteed channel performance"

Freq in MHz	Attn		NEXT			PSNEXT			ACR-F	
	in dB		in dB			in dB			in dB	
	Max	Typ	Std	Min	Typ	Std	Min	Typ	Std	Typ
1	<4	4.0	65.0	67.0	85.0	62.0	64.0	74.8	63.3	69.9
4	4.1	4.1	63.0	65.0	72.9	60.5	62.5	65.0	51.2	57.9
10	6.4	6.3	56.6	58.6	65.0	54.0	56.0	58.5	43.3	49.9
16	8.1	8.0	53.2	55.2	60.9	50.6	52.6	55.1	39.2	45.9
20	9.1	9.0	51.6	53.6	59.0	49.0	51.0	53.5	37.2	43.9
31.25	11.4	11.2	48.4	50.4	55.1	45.7	47.7	50.2	33.4	40.0
62.5	16.3	15.9	43.4	45.4	49.1	40.6	42.6	45.1	27.3	34.0
100	20.8	20.2	39.9	41.9	45.0	37.1	39.1	41.6	23.3	29.9
155	26.2	25.4	36.7	38.7	41.2	33.8	35.8	38.3	19.5	26.1
200	30.0	28.9	34.8	36.8	39.0	31.9	33.9	36.4	17.2	23.9
250	33.8	32.5	33.1	35.1	37.0	30.2	32.2	34.7	15.3	22.0
300	37.3	35.7	31.7	33.7	35.4	28.8	30.8	33.3	13.7	20.4
500	49.3	46.7	27.9	29.9	31.0	24.8	26.8	24.9	9.3	16.0

*Standard values based on ISO11801:2002/A1:2008 ClassEA

Electrical Performance LANmark-6A 4 Connector Channel Part 2

All values are based on Worst Case 4 Connector Channel configurations according ISO11801:2008 AM1 Minimal and maximum values represent guaranteed channel performance

Freq in MHz	PS ACR-F		PS ANEXT			PS AACR-F			RL		
	in dB		in dB			in dB			in dB		
	Std	Typ	Std	Min	Typ	Std	Min	Typ	Std	Min	Typ
1	60.3	66.9	80.0	90.0	92.0	77.0	92.0	94.0	19.0	21.0	21.0
4	48.2	54.9	74.0	89.0	91.0	65.0	80.0	82.0	19.0	21.0	32.0
10	40.3	46.9	70.0	85.0	87.0	57.0	72.0	74.0	19.0	21.0	28.0
16	36.2	42.9	68.0	83.0	85.0	52.9	67.9	69.9	18.0	20.0	26.0
20	34.2	40.9	67.0	82.0	84.0	51.0	66.0	68.0	17.5	19.5	25.0
31.25	30.4	37.0	65.1	80.1	82.1	47.1	62.1	64.1	16.5	18.5	23.1
62.5	24.3	31.0	62.0	77.0	79.0	41.1	56.1	58.1	14.0	16.0	20.0
100	20.3	26.9	60.0	75.0	77.0	37.0	52.0	54.0	12.0	14.0	18.0
155	16.5	23.1	57.1	72.1	74.1	33.2	48.2	50.2	10.1	12.1	16.1
200	14.2	20.9	55.5	70.5	72.5	31.0	46.0	48.0	9.0	11.0	15.0
250	12.3	19.0	54.0	69.0	71.0	29.0	44.0	46.0	8.0	10.0	14.0
300	10.7	17.4	52.8	67.8	69.8	27.5	42.5	44.5	8.0	10.0	13.2
500	6.3	13.0	49.5	64.5	66.5	23.0	38.0	40.0	8.0	10.0	11.0

*Standard values based on ISO11801:2002/A1:2008 ClassEA

LANmark-6A Ultim UniBoot Patch Cords

- High speed RJ45 patch cord to run 10GBase-T and future Cat6A applications
- High Density support : 48 cords on 1 height unit
- Frequency range up to 500MHz, fully complies to Cat 6A TIA568B.2-10 and ISO11801(2010) A2
- Individually screened pairs for reduced Internal Crosstalk and Alien Crosstalk immunity
- Externally certified
- Retrofit Latch Protector available in 8 colours for colour coding

Description

Application

LANmark-6A Ultim cords are developed to support 10 Gigabit Ethernet (IEEE 802.3an) and any other future Cat.6A application.

LANmark-6A Ultim Cords offer superior performance up to 500MHz and are matched with other LANmark-6A components to provide improved data throughput in complex channel configurations. Ultim cords use stranded cable and as such provide maximum system flexibility for the use at Cross Connects and Consolidation points.

They will also maximise the lifetime and longevity of the system by minimising the risk of wear & tear damage. Due to their good electrical performance and mechanical stability, LANmark-6A Ultim cords can be used for accurate field testing of Cat 6A cabling channels. .

Ultim Cords feature a slim boot for mechanical protection, which is kept inside the RJ45 boundaries to enable High Density Patching with 48 cords in 1 height unit.

They also come with a 'Replaceable' Latch Protector, which can be used for colour coding of different services.

Performance

The LANmark-6A Ultim cords fully comply and exceed the requirements of EIA/ TIA-568-B.2-10 and ISO11801 A2 and enable to achieve high performing Cat 6A channels. Used with other LANmark-6A components, very short Cat 6A link and channel configurations with up to 3 connection points within 10 meters can be supported.

Guarantees

When installed in combination with other LANmark-6A components, a 25 years channel warranty can be obtained, covering full 10GBase-T support and full Cat 6A/Class EA compliance.

Usage

- The cords are by design fully Alien Crosstalk compliant, so no special installation rules need to be taken into account for ANEXT and AFEXT compliance.
- 1, 2, 3, 5, 10, 20m are standard lengths available from stock, other lengths are available on demand.
- Orange and Dark Grey are standard colours available from stock; other colours are available on demand.
- Default Plug Configuration is a black boot with a preinstalled black latch protector.



LANmark-6A

Standards

International EN 50173-1;
 IEEE 802.3an; ISO/IEC 11801:2002/
 A2:2008; ISO/IEC TR24750;
 ISO11801:2002/A1:2008

National TIA/EIA TSB-155; TIA/
 EIA-568-B.3

Characteristics

Usage characteristics













Range

LANmark-6A

LANmark-6A Ultim UniBoot Patch Cords

Product List

☎ = Make to order, 📦 = Make to stock

Nexans ref.	Name	Length (m)	Colour	Screen
 N11A.U1F100DK New	LANmark-6A Ultim Patch Cord Cat 6A Screened LSZH 10m Grey	10	Grey	Yes
 N11A.U1F100OK New	LANmark-6A Ultim Patch Cord Cat 6A Screened LSZH 10m Orange	10	Orange	Yes
 N11A.U1F010DK New	LANmark-6A Ultim Patch Cord Cat 6A Screened LSZH 1m Grey	1	Grey	Yes
 N11A.U1F010OK New	LANmark-6A Ultim Patch Cord Cat 6A Screened LSZH 1m Orange	1	Orange	Yes
 N11A.U1F200DK New	LANmark-6A Ultim Patch Cord Cat 6A Screened LSZH 20m Grey	20	Grey	Yes
 N11A.U1F200OK New	LANmark-6A Ultim Patch Cord Cat 6A Screened LSZH 20m Orange	20	Orange	Yes
 N11A.U1F020DK New	LANmark-6A Ultim Patch Cord Cat 6A Screened LSZH 2m Grey	2	Grey	Yes
 N11A.U1F020OK New	LANmark-6A Ultim Patch Cord Cat 6A Screened LSZH 2m Orange	2	Orange	Yes
 N11A.U1F030DK New	LANmark-6A Ultim Patch Cord Cat 6A Screened LSZH 3m Grey	3	Grey	Yes
 N11A.U1F030OK New	LANmark-6A Ultim Patch Cord Cat 6A Screened LSZH 3m Orange	3	Orange	Yes
 N11A.U1F050DK New	LANmark-6A Ultim Patch Cord Cat 6A Screened LSZH 5m Grey	5	Grey	Yes
 N11A.U1F050OK New	LANmark-6A Ultim Patch Cord Cat 6A Screened LSZH 5m Orange	5	Orange	Yes

☎ = Make to order, 📦 = Make to stock

Electrical Performance LANmark-6A 4 Connector Channel Part 1

"All values are based on Worst Case 4 Connector Channel configurations according to ISO11801:2008 AM1. Minimal and maximum values represent guaranteed channel performance"

Freq in MHz	Attn in dB		NEXT in dB			PSNEXT in dB			ACR-F in dB	
	Max	Typ	Std	Min	Typ	Std	Min	Typ	Std	Typ
1	<4	4.0	65.0	67.0	85.0	62.0	64.0	74.8	63.3	69.9
4	4.1	4.1	63.0	65.0	72.9	60.5	62.5	65.0	51.2	57.9
10	6.4	6.3	56.6	58.6	65.0	54.0	56.0	58.5	43.3	49.9
16	8.1	8.0	53.2	55.2	60.9	50.6	52.6	55.1	39.2	45.9
20	9.1	9.0	51.6	53.6	59.0	49.0	51.0	53.5	37.2	43.9
31.25	11.4	11.2	48.4	50.4	55.1	45.7	47.7	50.2	33.4	40.0
62.5	16.3	15.9	43.4	45.4	49.1	40.6	42.6	45.1	27.3	34.0
100	20.8	20.2	39.9	41.9	45.0	37.1	39.1	41.6	23.3	29.9
155	26.2	25.4	36.7	38.7	41.2	33.8	35.8	38.3	19.5	26.1
200	30.0	28.9	34.8	36.8	39.0	31.9	33.9	36.4	17.2	23.9
250	33.8	32.5	33.1	35.1	37.0	30.2	32.2	34.7	15.3	22.0
300	37.3	35.7	31.7	33.7	35.4	28.8	30.8	33.3	13.7	20.4
500	49.3	46.7	27.9	29.9	31.0	24.8	26.8	24.9	9.3	16.0

*Standard values based on ISO11801:2002/A1:2008 ClassEA

LANmark-6A Ultim UniBoot Patch Cords

Electrical Performance LANmark-6A 4 Connector Channel Part 2

All values are based on Worst Case 4 Connector Channel configurations according ISO11801:2008 AM1 Minimal and maximum values represent guaranteed channel performance

Freq in MHz	PS ACR-F in dB		PS ANEXT in dB			PS AACR-F in dB			RL in dB		
	Std	Typ	Std	Min	Typ	Std	Min	Typ	Std	Min	Typ
1	60.3	66.9	80.0	90.0	92.0	77.0	92.0	94.0	19.0	21.0	21.0
4	48.2	54.9	74.0	89.0	91.0	65.0	80.0	82.0	19.0	21.0	32.0
10	40.3	46.9	70.0	85.0	87.0	57.0	72.0	74.0	19.0	21.0	28.0
16	36.2	42.9	68.0	83.0	85.0	52.9	67.9	69.9	18.0	20.0	26.0
20	34.2	40.9	67.0	82.0	84.0	51.0	66.0	68.0	17.5	19.5	25.0
31.25	30.4	37.0	65.1	80.1	82.1	47.1	62.1	64.1	16.5	18.5	23.1
62.5	24.3	31.0	62.0	77.0	79.0	41.1	56.1	58.1	14.0	16.0	20.0
100	20.3	26.9	60.0	75.0	77.0	37.0	52.0	54.0	12.0	14.0	18.0
155	16.5	23.1	57.1	72.1	74.1	33.2	48.2	50.2	10.1	12.1	16.1
200	14.2	20.9	55.5	70.5	72.5	31.0	46.0	48.0	9.0	11.0	15.0
250	12.3	19.0	54.0	69.0	71.0	29.0	44.0	46.0	8.0	10.0	14.0
300	10.7	17.4	52.8	67.8	69.8	27.5	42.5	44.5	8.0	10.0	13.2
500	6.3	13.0	49.5	64.5	66.5	23.0	38.0	40.0	8.0	10.0	11.0

*Standard values based on ISO11801:2002/A1:2008 ClassEA

Contact

LAN Systems (Nexans Cabling Solutions)
Phone: +44 (0)1256 486640
nxs.uk@nexans.com

Essential-6 Cable

- Unshielded construction
- Complies to the latest Category 6 standards
- Central cross maintains geometry and performance
- Supports Class E applications up to 250 MHz.

Description

Application

The Nexans Essential-6 cables are manufactured and tested to the latest Category 6 specifications. They are compatible with the complete Essential-6 modular and PCB connectivity range. When the cable is installed in conjunction with Essential-6 outlets and patch panels, a 25 year Class E Link Certificate can be obtained from the Nexans website.

Design

The conductors are 24 AWG solid copper wires complying with IEC 60228. The PE central cross filler keeps the pairs in place and reduces the risks of losing performance when bending the cable. The cable is available with a Light Grey PVC or an Orange LSZH outer jacket.

Performance

Nexans Essential-6 cables are compliant with the requirements of the TIA 568-B.2-1 and ISO/IEC 11801:2002.

Installation

Thanks to their small nominal outer diameter, the Essential-6 cables are as easy to install as their Cat 5e equivalent.



Standards

International ISO/IEC 11801
National TIA/EIA-568-B.2

Essential-6 Cable





Characteristics

Usage characteristics

Range

essential-6

Product List

Nexans ref.	Name	Type of cable	Outer sheath
 N100.161 New	Essential-6 U/UTP Cat 6 LSZH 305m box	U/UTP	LSZH
 N100.164 New	Essential-6 U/UTP Cat 6 LSZH 500m reel	U/UTP	LSZH
 N100.166 New	Essential-6 U/UTP Cat 6 PVC 305m box	U/UTP	PVC
 N100.169 New	Essential-6 U/UTP Cat 6 PVC 500m reel	U/UTP	PVC

☎ = Make to order, 📦 = Make to stock

Channel Performance

Values given for 2-connector channel, built with Essential-6 cable, outlet and patch panel.

Frequency MHz	Insertion Loss dB/100m	NEXT PP dB	PS NEXT dB	ACR dB/100m	PS ACR dB/100m	ELFEXT dB/100m	PSELFEXT dB/100m	Return Loss dB
1	4.0	65.0	62.0	65.0	62.0	63.3	60.3	19.0
4	4.2	63.0	60.5	58.9	56.4	51.2	48.2	19.0
10	6.6	56.6	54.0	50.0	47.4	43.3	40.3	19.0
16	8.3	53.2	50.6	44.9	42.3	39.2	36.2	18.0
20	9.3	51.6	49.0	42.3	39.7	37.2	34.2	17.5
31.25	11.7	48.4	45.7	36.7	34.0	33.4	30.4	16.5
62.5	16.9	43.4	40.6	26.5	23.7	27.3	24.3	14.0
100	21.7	39.9	37.1	18.2	15.4	23.3	20.3	12.0
155	27.6	36.7	33.8	9.1	6.2	19.5	16.5	10.1
200	31.7	34.8	31.9	3.1	0.1	17.2	14.2	9.0
250	35.9	33.1	30.2	-2.8	-5.8	15.3	12.3	8.0

All values are specified at 20°C.

Essential-6 Keystone Connector

- Complies with the latest Category 6 standards
- Screened and Unscreened versions
- Easy termination without punchdown tool
- Keystone format.

Description

Application

The Nexans Essential-6 keystone connectors are manufactured and tested to the latest Category 6 specifications. They support Class E applications up to 250 MHz. When installed in conjunction with Essential-6 cable and patch panels, a 25 year Class E Link Warranty can be obtained from the Nexans web site.

Design

The Essential-6 keystone connectors are designed to match with Essential-6 cable and patch cords and complement all Essential modular components, such as:

- keystone patch panels (black and white)
- keystone outlet modules (UK, US and European formats)

Please follow the links on this page to view the related datasheets.

The modular jack is designed for keystone footprints of 14.78mm width, 20-20.78mm height and 1.5mm wall thickness and is compatible with a variety of keystone formatted structural hardware. (Please check compatibility with Nexans before using 3rd party hardware)

The Essential-6 connectors can be used with all types of Category 6 cable with solid wire from 24 to 22 AWG.

Performance

The Essential-6 keystone connectors are compliant with the specifications of ISO/IEC 11801 and EN 50173.

Installation

The wire organiser guarantees fast and easy termination of the Essential-6 keystone connector without the need for a punchdown tool. An optional comfort tool (N420.567) can be used to increase the ease of installation.

- Fast and easy termination without punchdown tool.
- Wiring according to colour code T568B or T568A.
- Accepts 24, 23 and 22 AWG solid core cables.
- Fits Nexans hardware designed for keystone format







Standards

International ISO/IEC 11801

Essential-6 Keystone Connector

Product List

Nexans ref.	Name
 N420.136  New	Essential-6 Keystone Connector Screened
 N420.126  New	Essential-6 Keystone Connector Screened No Rear Cover
 N420.116	Essential-6 Keystone Connector Unscreened

☎ = Make to order, 📦 = Make to stock

Channel Performance

Values given for 2-connector channel, built with Essential-6 cable, outlet and patch panel.

Frequency MHz	Insertion Loss dB/100m	NEXT PP dB	PS NEXT dB	ACR dB/100m	PS ACR dB/100m	ELFEXT dB/100m	PSELFEXT dB/100m	Return Loss dB
1	4.0	65.0	62.0	65.0	62.0	63.3	60.3	19.0
4	4.2	63.0	60.5	58.9	56.4	51.2	48.2	19.0
10	6.6	56.6	54.0	50.0	47.4	43.3	40.3	19.0
16	8.3	53.2	50.6	44.9	42.3	39.2	36.2	18.0
20	9.3	51.6	49.0	42.3	39.7	37.2	34.2	17.5
31.25	11.7	48.4	45.7	36.7	34.0	33.4	30.4	16.5
62.5	16.9	43.4	40.6	26.5	23.7	27.3	24.3	14.0
100	21.7	39.9	37.1	18.2	15.4	23.3	20.3	12.0
155	27.6	36.7	33.8	9.1	6.2	19.5	16.5	10.1
200	31.7	34.8	31.9	3.1	0.1	17.2	14.2	9.0
250	35.9	33.1	30.2	-2.8	-5.8	15.3	12.3	8.0

All values are specified at 20°C.

Essential-6 Patch Panels

- Complies to the latest Category 6 standard
- Punchdown from the top or the rear side
- Unshielded

Description

Application

The Nexans Essential-6 patch panels are based on 19" frame dimensions and have 24 Category 6 RJ45 ports on 1HU. They support Class E applications up to 250 MHz. When the panels are installed in conjunction with Essential-6 cable and outlets, a 20 year Class E Link Certificate can be obtained from the Nexans e-service site.

Design

The Essential-6 patch panels are compatible with the complete Essential-6 range and can be used with all types of UTP Category 6 cable with solid wire from 22 to 24 AWG. The panels are available in either black or grey-white finish.

Performance

The Essential-6 patch panels are compliant with the specifications of ISO/IEC 11801:2002.

Installation

- Fast and easy termination of IDC blocks by LSA+ punchdown tooling.
- Colour code T568A and T568B (Product dependent).
- Supplied with fixings and tie-wraps.





Standards

International ISO/IEC 11801

Essential-6 Patch Panels

Product List

Nexans ref.	Name
 N424.610 New	Essential-6 Patch panel 1HU 24 Cat 6 ports, rear connection, black
 N424.613 New	Essential-6 Patch panel 1HU 24 Cat 6 ports, top connection, black

☎ = Make to order, 📦 = Make to stock

Channel Performance

Values given for 2-connector channel, built with Essential-6 cable, outlet and patch panel.

Frequency MHz	Insertion Loss dB/100m	NEXT PP dB	PS NEXT dB	ACR dB/100m	PS ACR dB/100m	ELFEXT dB/100m	PSELFEXT dB/100m	Return Loss dB
1	4.0	65.0	62.0	65.0	62.0	63.3	60.3	19.0
4	4.2	63.0	60.5	58.9	56.4	51.2	48.2	19.0
10	6.6	56.6	54.0	50.0	47.4	43.3	40.3	19.0
16	8.3	53.2	50.6	44.9	42.3	39.2	36.2	18.0
20	9.3	51.6	49.0	42.3	39.7	37.2	34.2	17.5
31.25	11.7	48.4	45.7	36.7	34.0	33.4	30.4	16.5
62.5	16.9	43.4	40.6	26.5	23.7	27.3	24.3	14.0
100	21.7	39.9	37.1	18.2	15.4	23.3	20.3	12.0
155	27.6	36.7	33.8	9.1	6.2	19.5	16.5	10.1
200	31.7	34.8	31.9	3.1	0.1	17.2	14.2	9.0
250	35.9	33.1	30.2	-2.8	-5.8	15.3	12.3	8.0

All values are specified at 20°C.

Essential-6 Outlet Modules

- Complies to the latest Category 6 standards
- Includes 25x50, LJ6C and 50x50 triple modules
- Unshielded
- LSA+ termination
- UK white
- Fits in all Nexans UK structural hardware

Description

Application

The Nexans Essential-6 unshielded outlet modules are manufactured and tested to the latest Category 6 specifications. They support Class E applications up to 250 MHz. When installed in conjunction with Essential-6 cable and patch panels, a 25 year Class E Link Certificate can be obtained from the Nexans e-service site.

Design

The Essential-6 outlet modules are compatible with the complete Essential-6 range and fit into all Nexans UK structural hardware. They can be used with all types of UTP Category 6 cable with solid wire from 22 to 24 AWG. The spring shuttered modules come in glossy white finish, matching with most British style structural hardware. They are available in different versions:

- single module 25x50mm
- single module 25x50mm - low profile
- triple module 50x50mm
- LJ6C module 25x37mm

The modules are equipped with transparent label holders fitted with a blank paper label for customised port identification.

Performance

The Essential-6 outlet modules are compliant with the specifications of ISO/IEC 11801: 2002.

Installation

- Fast and easy termination by LSA+ punch-down tooling.
- Wiring according to colour code T568B.
- Centrally positioned tie wrap bridges ensure cable strain relief.
- Supplied with tie wraps.
- Labelling windows included.
- Fits in all Nexans UK structural hardware









Standards

International ISO/IEC 11801

Essential-6 Outlet Modules

Product List

Nexans ref.	Name
 N424.623	Essential-6 LJ6C outlet module 25x39.5mm
 N424.621	Essential-6 single outlet module 25x50mm
 N424.620 New	Essential-6 single outlet module 25x50mm - Low Profile
 N424.622 To be removed	Essential-6 triple outlet module 50x50mm

 = Make to order,  = Make to stock

Channel Performance

Values given for 2-connector channel, built with Essential-6 cable, outlet and patch panel.

Frequency MHz	Insertion Loss dB/100m	NEXT PP dB	PS NEXT dB	ACR dB/100m	PS ACR dB/100m	ELFEXT dB/100m	PSELFEXT dB/100m	Return Loss dB
1	4.0	65.0	62.0	65.0	62.0	63.3	60.3	19.0
4	4.2	63.0	60.5	58.9	56.4	51.2	48.2	19.0
10	6.6	56.6	54.0	50.0	47.4	43.3	40.3	19.0
16	8.3	53.2	50.6	44.9	42.3	39.2	36.2	18.0
20	9.3	51.6	49.0	42.3	39.7	37.2	34.2	17.5
31.25	11.7	48.4	45.7	36.7	34.0	33.4	30.4	16.5
62.5	16.9	43.4	40.6	26.5	23.7	27.3	24.3	14.0
100	21.7	39.9	37.1	18.2	15.4	23.3	20.3	12.0
155	27.6	36.7	33.8	9.1	6.2	19.5	16.5	10.1
200	31.7	34.8	31.9	3.1	0.1	17.2	14.2	9.0
250	35.9	33.1	30.2	-2.8	-5.8	15.3	12.3	8.0

All values are specified at 20°C.

Essential-6 Patch Cords

- Comply with latest Category 6 standards
- Screened and unshielded
- Light grey PVC
- Light grey slimline boot with bend relief
- 1, 2, 3 and 5m lengths

Description

Application

The Nexans Essential-6 patch cords are manufactured and tested to the latest Category 6 specifications and support Class E applications up to 250 MHz. They are matched with the complete Essential-6 range in order to deliver a full end-to-end Class E Channel.

Design

The Essential-6 patch cords contain a central PE cross member, keeping the pairs in place and reducing the risk of losing performance when bending the cords. Available in standard lengths of 1, 2, 3 and 5m, each cord is individually bagged and carries a traceability code.

Performance

The Essential-6 cords are compliant with the specifications of ISO/IEC 11801 and EN 50173.

Installation

Thanks to their small outer diameter, the Essential-6 cords are as easy to install and manage in a rack as their Cat 5e equivalent.



essential-6

Standards

International ISO/IEC 11801



Flame retardant
IEC 60332-1

Essential-6 Patch Cords

Characteristics

Electrical characteristics	
Characteristic impedance	100 Ohm
Usage characteristics	
Range	essential-6
Flame retardant	IEC 60332-1

Product List

☎ = Make to order, 📦 = Make to stock

Nexans ref.	Name	Screen	Length (m)	Outer sheath	Colour
📦 N101.12ECGG New	Essential-6 Patch Cord FTP Cat 6 PVC Grey 1m	FTP	1	PVC	Light grey
📦 N101.12EEGG New	Essential-6 Patch Cord FTP Cat 6 PVC Grey 2m	FTP	2	PVC	Light grey
📦 N101.12EFGG New	Essential-6 Patch Cord FTP Cat 6 PVC Grey 3m	FTP	3	PVC	Light grey
📦 N101.12EHGG New	Essential-6 Patch Cord FTP Cat 6 PVC Grey 5m	FTP	5	PVC	Light grey
📦 N101.21ECCO New	Essential-6 Patch Cord UTP Cat 6 LSZH Orange 1m	UTP	1	LSZH	Orange
📦 N101.21EECO New	Essential-6 Patch Cord UTP Cat 6 LSZH Orange 2m	UTP	2	LSZH	Orange
📦 N101.21EFOO New	Essential-6 Patch Cord UTP Cat 6 LSZH Orange 3m	UTP	3	LSZH	Orange
📦 N101.21EHOO New	Essential-6 Patch Cord UTP Cat 6 LSZH Orange 5m	UTP	5	LSZH	Orange
📦 N101.11ECGG New	Essential-6 Patch Cord UTP Cat 6 PVC Grey 1m	UTP	1	PVC	Light grey
📦 N101.11EEGG New	Essential-6 Patch Cord UTP Cat 6 PVC Grey 2m	UTP	2	PVC	Light grey
📦 N101.11EFGG New	Essential-6 Patch Cord UTP Cat 6 PVC Grey 3m	UTP	3	PVC	Light grey
📦 N101.11EHGG New	Essential-6 Patch Cord UTP Cat 6 PVC Grey 5m	UTP	5	PVC	Light grey

☎ = Make to order, 📦 = Make to stock

Channel Performance

Values given for 2-connector channel, built with Essential-6 cable, outlet and patch panel.

Frequency MHz	Insertion Loss dB/100m	NEXT PP dB	PS NEXT dB	ACR dB/100m	PS ACR dB/100m	ELFEXT dB/100m	PSELFEXT dB/100m	Return Loss dB
1	4.0	65.0	62.0	65.0	62.0	63.3	60.3	19.0
4	4.2	63.0	60.5	58.9	56.4	51.2	48.2	19.0
10	6.6	56.6	54.0	50.0	47.4	43.3	40.3	19.0
16	8.3	53.2	50.6	44.9	42.3	39.2	36.2	18.0
20	9.3	51.6	49.0	42.3	39.7	37.2	34.2	17.5
31.25	11.7	48.4	45.7	36.7	34.0	33.4	30.4	16.5
62.5	16.9	43.4	40.6	26.5	23.7	27.3	24.3	14.0
100	21.7	39.9	37.1	18.2	15.4	23.3	20.3	12.0
155	27.6	36.7	33.8	9.1	6.2	19.5	16.5	10.1
200	31.7	34.8	31.9	3.1	0.1	17.2	14.2	9.0
250	35.9	33.1	30.2	-2.8	-5.8	15.3	12.3	8.0

Essential-6 Patch Cords

All values are specified at 20°C.

Category 7 / 7A

LANmark-7 is the highest performance standards compliant, copper solution available in the market. This Category 7 / Class F solution provides backwards compatible performance beyond 600MHz and features the revolutionary GG45 connector.

Recommended uses:

- Very long lifetime needs (>15years)
- Composite analogue & high speed digital data
- Multiple service applications (voice, data, video using different pairs in the same cable)
- Very high electromagnetic noise environments
- Installations where the replacement cost is very high (e.g. ships etc)

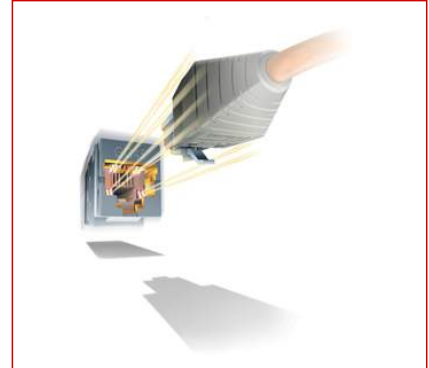

LANmark-7 Cable

- Exceeds Category 7 using 4 individually screened pairs
- Optimised for use with LANmark-7 GG45 connector
- Small outer diameter
- Easy to install due to a tight foil construction

Description

Description

LANmark-7 cable is a 4pr S/FTP with individual pair foils and an overall braid offering superior performance in terms of ACR. It is fully compliant with the Category 7 standards and when installed together with the GG45 LANmark-7 connector as a system is guaranteed to exceed all channel requirements in all configuration scenarios (up to 4-connector channels).

Application

LANmark-7 will support all current and planned data applications developed for cabling up to Class F.

- All Ethernet applications including
- 1000Base-T
- 1000Base-TX
- 10GBase-T
- CATV up to 862MHz
- Any future Class F application

Installation

Ease of Installation is one of the unique features of LANmark-7 cable. Extra attention has been paid to ensure screen coverage is maintained both during and after installation. The cable has been designed specifically to offer both optimum performance and ease of termination when used in conjunction with the LANmark-7 GG45 connector.



LANmark-7

Standards

International EN 50173;
EN 50288-4-1; ISO/IEC 11801; ISO/
IEC 61156-5

LANmark-7 Cable

Characteristics

Transmission characteristics

Velocity of propagation

80.0 %

Product List

☎ = Make to order, 📦 = Make to stock

Nexans ref.	Name	Type of cable	Category
☎ N100.376	LANmark-7 Lloyd's S/FTP Cat 7 23 AWG LSZH Blue 500m Reel	S/FTP	Cat. 7
📦 N100.365 New	LANmark-7 S/FTP Cat 7 600MHz 23 AWG LSZH Orange 1000m Reel	S/FTP	Cat. 7
📦 N100.367 New	LANmark-7 S/FTP Cat 7 600MHz Dual 2x23AWG LSZH Orange 500m Reel	S/FTP Shotgun	Cat. 7

☎ = Make to order, 📦 = Make to stock

Electrical Performance LANmark-7 600 S/FTP Cable

Electrical Performance LANmark-7 600 S/FTP Cable

Frequency (MHz)	Attenuation (dB/100m)		NEXT (in dB)		ACR (in dB)		PS-NEXT (in dB)		ACR-F (in dB)		PS-ACR-F (in dB)		Return Loss (in dB)	
	Max.	Typ.	Min.	Typ.	Min.	Typ.	Min.	Typ.	Min.	Typ.	Min.	Typ.	Min.	Typ.
	1.00	4.0	1.8	75.0	100.0	71.0	98.2	72.0	98.0	75.0	98.0	75.0	96.0	20.0
4.00	4.0	3.5	75.0	100.0	71.0	96.5	72.0	98.0	75.0	98.0	75.0	96.0	23.0	26.0
10.00	5.9	5.5	75.0	100.0	69.1	94.5	72.0	98.0	75.0	98.0	72.3	96.0	25.0	28.0
16.00	7.4	6.8	75.0	100.0	67.6	93.2	72.0	98.0	71.2	96.0	68.2	94.0	25.0	28.0
20.00	8.3	7.7	75.0	100.0	66.7	92.3	72.0	98.0	69.3	94.0	66.3	92.0	25.0	28.0
31.25	10.4	9.6	75.0	100.0	64.6	90.4	72.0	98.0	65.4	90.0	62.4	88.0	23.6	26.0
62.50	14.9	14.0	75.0	100.0	60.1	86.0	72.0	98.0	59.4	84.0	56.4	82.0	21.5	25.0
100.00	19.0	17.7	72.4	100.0	53.4	82.3	69.4	98.0	55.3	75.0	52.3	73.0	20.1	24.0
155.00	24.0	22.8	69.5	96.0	45.6	73.2	66.5	93.0	51.5	70.0	48.5	68.0	18.8	23.0
250.00	31.0	29.0	66.4	94.0	35.5	65.0	63.4	91.0	47.3	66.0	44.3	64.0	17.3	22.0
300.00	34.2	32.1	65.2	92.0	31.1	59.9	62.2	88.0	45.8	54.0	42.8	52.0	17.3	20.0
600.00	50.1	45.5	60.7	90.0	10.6	44.5	57.7	86.0	39.7	54.0	36.7	52.0	17.3	20.0

all values are specified at 20°C

LANmark-7 GG45 Connector

LANmark-7 GG45

- High speed '2 in 1' Multimedia Connector
- Supports data applications up to 600 MHz Class F
- Supports CATV VHF and UHF up to 1000MHz
- Backwards compatible
- Switch Inside
- Compatible with ISO 11801 (enterprise cabling)
- Compatible with ISO 15018 (residential cabling)
- Fits in all Nexans modular Snap-In structural hardware

Description

Description

LANmark-7 GG45 is a standardised High Speed '2 in 1' Snap-In Connector, which contains a full Cat 6 (RJ45) Interface as well as a full Cat 7 Interface, using additional contacts for the 600 MHz transmission.

LANmark-7 offers uniquely backwards compatible services realised through an incorporated switch, which activates a maximum of 8 out of 12 contacts. For 100/250 MHz transmission performance, the upper 8 RJ45 contacts are used, for 600 MHz the 8 contacts in the extreme corners are used.

The LANmark-7 GG45 Snap-In Connector is part of the Nexans modular Snap-In system and fits in all structural hardware designed for this range. It is a full-screened connector with 360° EMC protection. 4 versions of LANmark-7 GG45 are available: one for solid cables, one for stranded cables, a UL version and a Heavy Duty connector for harsh environments. The version of GG45 for stranded wire is especially made for networks, which use 3/4 Connector Links and so called Consolidation Points to achieve higher flexibility. GG45 for stranded wire can terminate single ended flexible patch cords at those Consolidation Points.

An optional adapter clip can be added to fit the outer dimensions of the international well-known keystone format.

Application

LANmark-7 GG45 supports all data applications defined for Cat 5, Cat 5E, Cat 6 and Cat 7 such as 10BaseT, 100BaseT, Gigabit Ethernet, 1000BaseTX, 1GBaseTX2 over Class F, 1GBaseTX4 over Class F, 10GBaseT according IEEE802.3.AN, 155 ATM, 622 ATM, 1G ATM (CB1G)

Performance

The LANmark-7 GG45 Snap-In Connector has been designed to reach the highest performance in Cat 6, Cat 7 and broadcast applications (as for example ISO 15018 residential cabling). It has outstanding performance for attenuation (insertion loss), NEXT/FEXT, Power Sum NEXT/FEXT and RETURN LOSS. A metal cross inside the connector ensures the high NEXT performance in Cat 6 and Cat 7 mode. Excellent Return Loss Values ensure that LANmark-7 GG45 in addition to all Data applications is best suited to support CATV signals up to 1000 MHz.



LANmark-7

Standards

International ISO/IEC 11801

Product List

☎ = Make to order, 📦 = Make to stock

Nexans ref.	Name
📦 N420.730	LANmark-7 GG45 12C Snap-In Connector Cat 7 600MHz Screened
📦 N420.731	LANmark-7 GG45 12C Snap-In Connector Cat 7 600MHz Screened for stranded wire

☎ = Make to order, 📦 = Make to stock

LANmark-7 GG45 Connector

Selling delivery information

Guarantees

The LANmark-7 GG45 Snap-In Connector is fully compliant with the current ISO Cat 6 and Cat 7 standard and exceeds all parameters with substantial headroom.

When combined with LANmark Cat 6 or Cat 7 Cables and Patch Cords a full 25 year Class E and F Channel Warranty can be obtained.

Installation

The LANmark-7 GG45 Snap-In connector is designed to be terminated without punch down tools. For fast and easy installation of large volumes, an optional Comfort Tool can be used.

- Versions for solid cable: accepts 24, 23 and 22 AWG cable
- Version for stranded cable: accepts 26 AWG flex cable
- Fast termination of cable using Nexans wire organiser
- Colour code : TSB568A and TSB568B

Contact

LAN Systems (Nexans Cabling Solutions)
Phone: +44 (0)1256 486640
ncs.uk@nexans.com

GG45 8C PCB jack

LANmark-7 GG45

- Right angled Cat 7A PCB jack up to 1500 MHz
- to be used in active equipment or patch panels
- UL94-V0 plastic components
- RoHS compliant
- Wave solder compatible.

Description

Please refer to the datasheet of N420.738 for more detailed information and performance tables.

**LANmark-7****Standards**

International ISO/IEC 11801

GG45 8C PCB jack

Characteristics

Construction characteristics	
Colour	Black
Screen	Yes
Connector type	Female
Dimensional characteristics	
Height	13.5 mm
Width	15.24 mm
Depth	21.84 mm
Usage characteristics	
Component function	Connector

Product List

Nexans ref.	Name	Category	Range
☎ N420.738 New	GG45 Right angle 8 contact jack for PCB mount	Cat. 7A	LANmark-7A
		☎ = Make to order, 📦 = Make to stock	

LANmark-7 Patch Cords

Nexans Cat 7 Patch Cords

- High speed multimedia patch cord
- 600 MHz according IEC61076-3-110
- Allow full 4-conductor Class F channels
- Compatible with ISO 11801 (Office environment)
- Compatible with ISO 15018 standard (Residential environment)

Description

Application

Nexans LANmark-7 patch cords with GG45 non switched plugs enable a GG45 permanent link to be used in 600 MHz mode. The protruding part on the plug activates the switch within the GG45 jack and terminates the not used contacts of RJ45 to ground. Using the contacts in the extreme outer corners of the RJ45 interface for transmission, excellent NEXT and Return Loss performance are achieved.

Nexans LANmark-7 patch cords maximise the full performance of the channel and will exceed the requirements of the ISO 4 connector model. This provides improved data throughput up to 600 MHz and allows for the inclusion of additional patching or Consolidation Points for maximum system flexibility and all future data applications according ISO 11801.

- High Speed Multimedia patch cords
- Screened
- 2 x GG45 4-pair, non backwards compatible plugs

Guarantees

- Reliable connections over the lifetime of the cabling system.
- Compatible with IEC 61076-3-110
- Compatible with Class F standard (ISO 11801)
- Compatible with Residential standard (ISO 15018) for BCT applications

Installation

- Rugged construction
 - high connector retention force due to moulded connectors
 - external strain relief
 - self-latching, high reliability GG45 (IEC61076-3-110) screened connectors
 - sidebars on the plug avoid errors by using the patch cord for RJ45 jacks
- A Low Smoke Zero Halogen - Flame Retardant jacket is standard
- Orange is standard, different colors are available on request, subject to quantity and availability
- 1, 2, 3 and 5m are standard lengths, others lengths are available on demand

**LANmark-7**

Standards

International ISO/IEC 11801

Fire retardant
IEC 60332 Part 1

LANmark-7 Patch Cords

Characteristics

Construction characteristics	
Outer sheath	LSZH-FR
Colour	Orange
Electrical characteristics	
Characteristic impedance	100 Ohm
Usage characteristics	
Fire retardant	IEC 60332 Part 1

Product List

☎ = Make to order, 📦 = Make to stock

Nexans ref.	Name	Mechanical durability/ matings	Length (m)	Nominal outer diameter (mm)	Range
📦 N900.679	LANmark-7 Measurement Cord Cat 7 GG45 4P/GG45 4P LSZH-FR SCR 2 M ORANGE	1000	2	6.35	LANmark-7
📦 N101.239EO	LANmark-7 Patch Cord Cat 7 GG45 4P/GG45 4P LSZH FR SCR 2 M ORANGE	750	2	6.35	LANmark-7
📦 N101.239FO	LANmark-7 Patch Cord Cat 7 GG45 4P/GG45 4P LSZH-FR SCR 3 M ORANGE	750	3	6.35	LANmark-7
📦 N101.239HO	LANmark-7 Patch Cord Cat 7 GG45 4P/GG45 4P LSZH-FR SCR 5 M ORANGE	750	5	6.35	LANmark-7
📦 N101.269OO	LANmark-7 Single End Cord Cat 7 GG45 4P LSZH-FR SCR 10 M ORANGE	750	10	6.35	LANmark-7

☎ = Make to order, 📦 = Make to stock

LANmark-7 Splitter Cords

- Patch cords to allow application sharing with GG45
- Up to 4 applications simultaneously
- Compatible with ISO 11801
- Compatible with ISO 15018 draft

Description

Application

LANmark-7 Splitter cords allow to run multiple applications at the same time using only 1 GG45 permanent link.

LANmark-7 cable provides 4 individually shielded cable pairs . The GG45 Connector maintains the individual shields due to its internal metal cross and creates 4 completely shielded end to end communications channels, which can be used by different applications simultaneously. The LANmark-7 splitter cords allow to address each communication channel individually.

Many applications do not use all 4-pairs provided by the cable. Analogue telephony and CATV for example need only 1 pair, many data protocols like Ethernet and Fast Ethernet use 2 pairs.

Broadband Applications supported

LANmark-7 systems support CATV/CCTV applications and comply with the requirement for BCT in the ISO15018 Draft for Home Applications. Each of the 4 communication channels supports the CATV/CCTV applications up to 1000MHZ.

Up to the maximum of 4 pairs different combinations are supported:

- 4 services : eg. 4 x 1 pair applications such as voice, fax, CATV/CCTV
- 3 services: eg. 2 x 1 pair applications plus 1 x 2 application such as Ethernet or Fast Ethernet
- 2 services: eg. 2 x 2 pair applications
- 1 service: eg. 1 x 4 pair application such as Gigabit Ethernet

Description

The patch cords always have 1 GG45 Plug on the wall outlet side and multiple connectors on the user side. The GG45 Plugs terminates up to 3 cables, held together by a molded boot. On the user side the patch cords use standard RJ45 or RJ11 connectors.

Guarantees

- Reliable connections with LANmark-7 GG45 and User Terminals
- up to 750 insertions
- Compatible with IEC 61076-3-110 and IEC 60603-7 series

Properties

- Grey Color



LANmark-7

Standards

International ISO/IEC 11801



Flame retardant
IEC 60332-1

LANmark-7 Splitter Cords

Characteristics

Construction characteristics	
Outer sheath	LSZH-FR
Sheath colour	Light grey
Electrical characteristics	
Characteristic impedance	100 Ohm
Usage characteristics	
Mechanical durability/matings	750
Range	LANmark-7
Flame retardant	IEC 60332-1

Product List

☎ = Make to order, 📦 = Make to stock

Nexans ref.	Name	Length (m)
☎ N101.2B9CG New	Splitter Patch Cord GG45 - 1xEthernet RJ45 - 2xVoiceRJ11 Screened 1m LSZH Grey	1
☎ N101.2B9EG New	Splitter Patch Cord GG45 - 1xEthernet RJ45 - 2xVoiceRJ11 Screened 2m LSZH Grey	2
☎ N101.2B9FG New	Splitter Patch Cord GG45 - 1xEthernet RJ45 - 2xVoiceRJ11 Screened 3m LSZH Grey	3
☎ N101.2B9HG New	Splitter Patch Cord GG45 - 1xEthernet RJ45 - 2xVoiceRJ11 Screened 5m LSZH Grey	5
📦 N101.2A9CG New	Splitter Patch Cord GG45 - 2xEthernet RJ45 Screened 1m LSZH Grey	1
📦 N101.2A9EG New	Splitter Patch Cord GG45 - 2xEthernet RJ45 Screened 2m LSZH Grey	2
📦 N101.2A9FG New	Splitter Patch Cord GG45 - 2xEthernet RJ45 Screened 3m LSZH Grey	3
📦 N101.2A9HG New	Splitter Patch Cord GG45 - 2xEthernet RJ45 Screened 5m LSZH Grey	5

☎ = Make to order, 📦 = Make to stock

LANmark-7A Cable

- Exceeds Category 7A in terms of ACR and Frequency Range
- Suitable for channels with capacity above 40GBps over 100m
- Superior Performance with positive ACR over the full frequency range
- Optimised for use with LANmark-7A GG45 connector
- Easy to install with Cat 7 connectivity through special foil construction

Description

Description

LANmark-7A is a 4 pair S/FTP cable with individual pair foils and an overall braid offering superior performance up to 1200MHz. It is fully compliant with the new Category 7A standard and offers even large headroom above the Cat 7A requirement. Due to this excellent electrical performance and positive ACR up to 1000 / 1200MHz the cable is suited for transmission channels with a capacity of >40Gbps over 100m.

Application

LANmark-7A is the highest performing standardised cabling solution in the market and will support all current data applications and all planned applications using cabling up to Class FA (see discussions at IEEE about 40/100Gbps).

- All Ethernet applications including
- 10/100/1000Base-T
- 1000Base-TX
- 10GBase-T
- CaTV up to 862MHz
- Cable sharing applications including CATV
- Any future Class FA application

Installation

Ease of Installation is one of the main features of the LANmark-7A cable. Extra attention has been paid to ensure that the screen coverage is maintained and foils do not open during installation. The cable has been specially designed to be used in conjunction with the LANmark-7A GG45 12C connector.



LANmark-7A

Standards

International EN 50173;
EN 50288-4-1; ISO/IEC 11801; ISO/
IEC 61156-5

LANmark-7A GG45 Connector

LANmark-7A GG45

- First RJ45-compatible Cat 7A connector using Nexans unique GG45 interface
- Able to support future 40Gigabit Ethernet application
- Able to provide Shannon Capacity of 50Gbps over 100m
- Full Class FA channel compliancy according to ISO11801 Amendment 1
- Fully screened for Alien Crosstalk Immunity
- "2 in 1" Connector using 12 contacts to run 2 separate transmission modes
- Compatible with all Snap-In panels and outlets

Description

Description

LANmark-7A GG45 is a screened RJ45-compatible cable jack specified up to 1000MHz. It is designed specifically to support the high frequencies required for applications beyond 10 Gigabit Ethernet. Combined with LANmark7A Cable and Patch Cords, LANmark-7A GG45 has double the frequency range and half of the crosstalk compared to Cat6A and provides excellent transmission capacity up to 50Gbps over 100m (4-times of Cat6A). LANmark-7A GG45 uses 12 contacts: 8 contacts for the 1200MHz transmission (GG-mode) and 4 additional contacts to ensure RJ45 compatibility (RJ Mode). Thanks to its 360° screening and a fully closed rear cover, the connector allows excellent coupling attenuation and ensures immunity from alien crosstalk and other external interference. The LANmark-7A GG45 connector fits in all structural hardware designed for the Snap-In Connectors and can be used in all positions of a 4 connector twisted pair cabling channel (PP, CC, CP, TO).

Applications

- 10Base-T Ethernet
- 100Base-TX Fast Ethernet
- 1000Base-TX Gigabit Ethernet
- 10GBase-T 10 Gigabit Ethernet IEEE 802.3
- 155 Mbit ATM
- 1.2 Gbit ATM
- CATV up to 862MHz
- all future Cat 6A and Class EA applications
- all future Cat 7 and Class F applications
- all future Cat 7 and Class FA applications

Performance

The LANmark-7A GG45 12C Snap-In Connector is the first RJ45 compatible which meets the stringent requirements of Cat 7A up to 1000MHz. It has outstanding performance for Insertion Loss, Return Loss, NEXT/FEXT, Power Sum NEXT/FEXT, and especially Alien Crosstalk.

When used in combination with Nexans LANmark-7A cables and LANmark-7A patch cords, the four-connector channel meets Class FA requirements as defined in ISO/IEC11801 amendment 1.

Installation

The LANmark-7A GG45 12C Snap-In Connector makes use of Nexans wire organiser and is therefore very easy and fast to terminate. Using the Nexans patented Easy Termination Tool for GG45 the termination of GG45 is fool-proof and very reliable. A stranded version is available to allow the use of flexible stranded cable in cross connects or consolidation points.

**LANmark-7A**

Standards

International EN 50173-1;
IEC 60603-7-5; ISO/IEC 11801

LANmark-7A GG45 Connector

- Fast termination with exclusive wire organizer
- Colour code : T568A & T568B
- 360° EMC protection
- Accepts solid wire from 22 to 24 AWG
- Stranded version available for consolidation point
- Snap-in format fits in all Nexans structural hardware
- 2 possibilities to terminate the drain wire : on the housing or on the rear cover
- Can be turned into keystone format using additional adapter

Guarantees

The LANmark-7A GG45 12C Snap-In Connector is covered by the guarantee as described in "The General Terms and Conditions of Sales". When installed in combination with other LANmark-7A components, a 25 years channel warranty can be obtained, covering full Cat 7A/Class FA compliance.

LANmark-7A GG45 Connector

Product List

Nexans ref.	Name	Height (mm)	Width (mm)	Depth (mm)
☐ N420.735	LANmark-7A GG45 12C Snap-In Connector Cat 7A 1000MHz Screened	19.5	17	41.4
☐ N420.736	LANmark-7A GG45 12C Snap-In Connector Cat 7A 1000MHz Screened for stranded wire	19.5	17	41.4

☎ = Make to order, ☐ = Make to stock

Electrical Performance LANmark-7A

Typical Data given for Worst Case 4-Connector Channel Configurations

Frequency (in MHz)	Attenuation (in dB)		NEXT pp (in dB)		ACR-F (in dB)		RL (in dB)		Coupling Att. (in dB)		PSANEXT (in dB)		PSAFEXT (in dB)	
	Max	Typical	Min	Typical	Min	Typical	Min	Typical	Min	Typical	Min	Typical	Min	Typical
1	4.0	3.6	65.0	104.8	65.0	70.0	19.0	38.0	80.0	106.0	67.0	82.0	80.0	95.0
4	4.1	3.7	65.0	94.6	65.0	70.0	19.0	32.0	68.0	94.0	67.0	82.0	79.8	94.8
10	6.4	5.7	65.0	87.8	65.0	70.0	19.0	28.0	60.0	86.0	67.0	82.0	75.9	90.9
16	8.0	7.2	65.0	84.2	63.3	68.3	18.0	26.0	55.9	81.9	67.0	82.0	73.9	88.9
20	9.0	8.1	65.0	82.5	61.4	66.4	17.5	25.0	54.0	80.0	67.0	82.0	72.9	87.9
31.25	11.2	10.1	65.0	79.1	57.5	62.5	16.5	23.1	50.1	76.1	67.0	82.0	71.0	86.0
62.5	15.9	14.3	65.0	73.7	51.5	56.5	14.0	20.0	44.1	70.1	67.0	82.0	68.0	83.0
100	20.3	18.2	65.0	70.0	47.4	52.4	12.0	18.0	40.0	66.0	67.0	82.0	65.9	80.9
155	25.4	22.8	63.0	66.6	43.6	48.6	10.1	16.1	36.2	62.2	67.0	82.0	63.9	78.9
200	28.9	26.0	60.9	64.6	41.4	46.4	9.0	15.0	34.0	60.0	67.0	82.0	62.8	77.8
250	32.5	29.2	59.1	62.8	39.4	44.4	8.0	14.0	32.0	58.0	67.0	82.0	61.8	76.8
300	35.7	32.1	57.7	61.3	37.8	42.8	8.0	13.2	30.5	56.5	67.0	82.0	60.9	75.9
500	46.7	42.0	53.6	57.2	33.4	38.4	8.0	11.0	26.0	52.0	64.5	79.5	58.6	73.6
600	51.4	46.3	52.1	55.8	31.8	36.8	8.0	10.2	24.4	50.4	63.3	78.3	57.8	72.8
700	55.8	50.2	50.8	54.5	30.5	35.5	7.5	9.5	23.1	49.1	62.3	77.3	57.1	72.1
800	59.9	53.9	49.7	53.5	29.3	34.3	7.0	9.0	21.9	47.9	61.5	76.5	56.4	71.4
900	63.8	57.5	48.8	52.5	28.3	33.3	6.5	8.5	20.9	46.9	60.7	75.7	55.9	70.9
1000	67.6	60.8	47.9	51.6	27.4	32.4	6.0	8.0	20.0	46.0	60.0	75.0	55.4	70.4

all values are specified at 20°C

LANmark-7A Patch Cord

LANmark-7A GG45 Patchcords

- High bandwidth patch cord for 40 Gigabit applications and beyond
- Runs the GG45 '2in1' Connector in its high speed GG-Mode
- Both Sides use GG45 8 Contact Plugs up to 1000 MHz according IEC61076-3-110
- Allow full 4-connector Class FA channels
- Compatible with High Density requirements in Data Centres

Description

Description

Nexans LANmark-7A patch cords with GG45 8C non-switched plugs enable a GG45 7A permanent link to be used in 1000 MHz mode. The protruding part on the plug activates the switch within the GG45 7A "2in1" jack and terminates the none used contacts of RJ45 to ground. Using the contacts in the extreme outer corners of the RJ45 interface for transmission, excellent NEXT and Return Loss performances are achieved.

Nexans LANmark-7A patch cords maximise the full performance of the channel and will exceed the requirements of the ISO 4 connector model. This provides improved data throughput up to 1000 MHz and allows for the inclusion of additional patching or Consolidation Points for maximum system flexibility and all future data applications according ISO 11801.

- High Speed patch cords
- Screened
- 2 x GG45 8C 4-pair

Guarantees

- Reliable connections over the lifetime of the cabling system.
- Compatible with IEC 61076-3-110
- Compatible with Class F and Class FA standards (ISO 11801:2008)

Installation

- Look and Feel of a RJ45 plug (just using different contact positions)
- Self-latching, high reliability GG45 (IEC61076-3-110) screened connectors
- Sidebars on the plug avoid errors by using the patch cord for RJ45 jacks
- Low Smoke Halogen Free - Flame Retardant cable jacket
- Orange color, different colors available on request
- 1, 2, 3 and 5m lengths, others lengths available on request

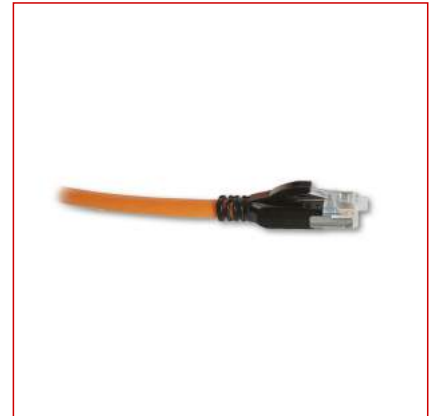
**LANmark-7A**

Standards

International ISO/IEC 11801

LANmark-7A Patch Cord



Characteristics

Construction characteristics

Colour

Orange

Product List

 = Make to order,  = Make to stock

Nexans ref.	Name
 N900.67A New	CAT7A Measurement Cord GG45 8C LSZH Orange 2m
 N101.23AOO New	LANmark-7A Patch Cord Cat 7A 1GHz GG45 8C Screened LSZH Orange 10m
 N101.23ARO New	LANmark-7A Patch Cord Cat 7A 1GHz GG45 8C Screened LSZH Orange 20m
 N101.23AEO New	LANmark-7A Patch Cord Cat 7A 1GHz GG45 8C Screened LSZH Orange 2m
 N101.23AFO New	LANmark-7A Patch Cord Cat 7A 1GHz GG45 8C Screened LSZH Orange 3m
 N101.23AHO New	LANmark-7A Patch Cord Cat 7A 1GHz GG45 8C Screened LSZH Orange 5m

 = Make to order,  = Make to stock

Electrical Performance LANmark-7A

Typical Data given for Worst Case 4-Connector Channel Configurations

Frequency (in MHz)	Attenuation (in dB)		NEXT pp (in dB)		ACR-F (in dB)		RL (in dB)		Coupling Att. (in dB)		PSANEXT (in dB)		PSAFEXT (in dB)	
	Max	Typical	Min	Typical	Min	Typical	Min	Typical	Min	Typical	Min	Typical	Min	Typical
1	4.0	3.6	65.0	104.8	65.0	70.0	19.0	38.0	80.0	106.0	67.0	82.0	80.0	95.0
4	4.1	3.7	65.0	94.6	65.0	70.0	19.0	32.0	68.0	94.0	67.0	82.0	79.8	94.8
10	6.4	5.7	65.0	87.8	65.0	70.0	19.0	28.0	60.0	86.0	67.0	82.0	75.9	90.9
16	8.0	7.2	65.0	84.2	63.3	68.3	18.0	26.0	55.9	81.9	67.0	82.0	73.9	88.9
20	9.0	8.1	65.0	82.5	61.4	66.4	17.5	25.0	54.0	80.0	67.0	82.0	72.9	87.9
31.25	11.2	10.1	65.0	79.1	57.5	62.5	16.5	23.1	50.1	76.1	67.0	82.0	71.0	86.0
62.5	15.9	14.3	65.0	73.7	51.5	56.5	14.0	20.0	44.1	70.1	67.0	82.0	68.0	83.0
100	20.3	18.2	65.0	70.0	47.4	52.4	12.0	18.0	40.0	66.0	67.0	82.0	65.9	80.9
155	25.4	22.8	63.0	66.6	43.6	48.6	10.1	16.1	36.2	62.2	67.0	82.0	63.9	78.9
200	28.9	26.0	60.9	64.6	41.4	46.4	9.0	15.0	34.0	60.0	67.0	82.0	62.8	77.8
250	32.5	29.2	59.1	62.8	39.4	44.4	8.0	14.0	32.0	58.0	67.0	82.0	61.8	76.8
300	35.7	32.1	57.7	61.3	37.8	42.8	8.0	13.2	30.5	56.5	67.0	82.0	60.9	75.9
500	46.7	42.0	53.6	57.2	33.4	38.4	8.0	11.0	26.0	52.0	64.5	79.5	58.6	73.6
600	51.4	46.3	52.1	55.8	31.8	36.8	8.0	10.2	24.4	50.4	63.3	78.3	57.8	72.8
700	55.8	50.2	50.8	54.5	30.5	35.5	7.5	9.5	23.1	49.1	62.3	77.3	57.1	72.1
800	59.9	53.9	49.7	53.5	29.3	34.3	7.0	9.0	21.9	47.9	61.5	76.5	56.4	71.4
900	63.8	57.5	48.8	52.5	28.3	33.3	6.5	8.5	20.9	46.9	60.7	75.7	55.9	70.9
1000	67.6	60.8	47.9	51.6	27.4	32.4	6.0	8.0	20.0	46.0	60.0	75.0	55.4	70.4

all values are specified at 20°C

Modular Patch Panels

Snap-In Patch Panels

- Compatible with all Snap-In connectors
- 24 ports
- Sliding and Fixed versions available
- Clip-On mechanism
- Exclusive Auto-Connect Earthing system
- Universal design supporting Unscreened and Screened connectors
- Shuttered versions available

Description

Nexans Snap-In range of patch panels are designed to accommodate any of the Snap-In connectors in the LANmark product family (LANmark-7A, LANmark-6A, LANmark-6, and LANmark-5).

The Snap-In panels feature an exclusive Clip-On system to secure the connector in the panel and to provide a simple means of earthing shielded connectors to facilitate installation. Connection of the panel to earth is achieved with a unique Auto-Connect feature removing the need for individual bonding conductors.

The panels are Nexans branded and have a series of complementary cable management products such as blank panels and patch cord guides.

The patch panels are designed for standard 19" enclosures, are 1U high, and support the following common features:

- 24 Ports with shutters
- Designed for Screened and Unscreened Snap-In connectors
- Compatible with all performance categories of connector
- Clip-On mechanism for simple earthing
- Exclusive rear cable management facilities
- Robust construction

Nexans offers three main panel versions:

- Angled Panels to support high density environments
- Sliding Panels to allow quick installation and easy maintenance which feature a flexible label for port numbering
- Fixed Panels using screen printed numbering systems for labelling
- The sliding and fixed panels also have LANSense Upgradeable versions



LANmark

Standards

International
Manufacturer specification

Snap-In Patch Panels

Product List

☎ = Make to order, 📦 = Make to stock

Nexans ref.	Name
📦 N521.671	Angled Patch Panel 24 Snap-In Black
📦 N521.675	Angled Patch Panel 24 Snap-In White
📦 N521.661BK	Patch Panel 24 Snap-In Fixed Black
📦 N521.661	Patch Panel 24 Snap-In Fixed White
📦 N521.663	Patch Panel 24 Snap-In Sliding White
📦 N521.881	Upgradable Patch Panel 24 Snap-In Fixed Black
📦 N521.861	Upgradable Patch Panel 24 Snap-In Sliding Black
📦 N521.865	Upgradable Patch Panel 24 Snap-In Sliding White

☎ = Make to order, 📦 = Make to stock

Empty Patch Panels for Keystone Connectors

- Compatible with Nexans keystone connectors
- Designed for Essential-5 and -6 range
- 24 ports on 1HU
- Tie wrap strain relief
- Earthing and grounding features
- Available in black or white

Description

Application

The modular patch panels for keystone connectors are fixed panels based on 19" frame dimensions and can house up to 24 keystone connectors on 1HU.

Design

The patch panels are designed to accommodate 24 Nexans Essential keystone connectors. The metalwork at the back of the panel is made of unpainted steel to enable automatic earthing and the necessary grounding when using shielded cable and connectors. The painted front plate allows a neat flush mounting of the connectors. The panels have screen-printed numbering 1-24 above the ports and a labelling field at the right end for patch panel numbering. They are available in black (N521.660BK) and in white (N521.660).

Installation

The Nexans keystone connectors can easily be inserted by a simple "one-click" movement, without the need for any tool. They are also easy to remove, when necessary.

The integrated cable fixing plate with tie wrap strain relief ensures cable management and retention.

The panels are supplied with fixings.

An optional 19" outrigger can be used for easy termination access (N500.120).







essential-6

Standards

International ISO/IEC 11801

Empty Patch Panels for Keystone Connectors

Product List

Nexans ref.	Name
 N521.660BK	Empty Patch Panel for 24 keystone connectors black
 N521.660	Empty Patch Panel for 24 keystone connectors white
 N521.660BK New	Essential Patch Panel 24 Keystone Black - New Design
 N521.660 New	Essential Patch Panel 24 Keystone White - New Design

☎ = Make to order, 📦 = Make to stock

Modular Outlets

Hardware-LANmark

- For all 45x45mm fittings.
- Modules, Cover Plates, Surface Box
- Modules include labeling and shutters.
- Suitable for all snap-in connectors.
- Angled modules for restricted depth.
- Easy click-in mechanism.

Description

Application

This range of outlet mounting hardware is suitable for all 45mm fittings and includes cover plates, flat & angled modules for Snap-in connectors, and surface mount boxes.

For the specific information on the Snap-in connectors, refer to the corresponding data sheets.

There are two different faceplates to support all environments:

- The straight version
- The angled version. It offers the ideal solution for cable trays and floor boxes, where depth is restricted. Shutters prevent dust entrance.

Guarantees

- All plastic material is UL 94V0

Installation

These modular outlets fit into a wide range of international 45x45 covering plates and surface mount boxes.

For easy management and port identification, the outlets all include integrated labelling windows.









The Snap-in connectors are inserted into the modular outlet by a simple click-in mechanism.





Standards

International
 Manufacturer specification

Product List

Nexans ref.	Name	Width (mm)	Colour	Height (mm)	Depth (mm)
 N200.051	LANmark EU style 45 x 45 frame ivory	80	Ivory	80	
 N200.050	LANmark EU style 45 x 45 frame white	80	White RAL 9010	80	
 N423.550	LANmark EU style 45 x 45 module 2 Snap-In flat white	45	White RAL 9010	45	
 N200.115	LANmark EU style 45 x 45 surface mount box ivory	82	Ivory	82	50
 N200.116	LANmark EU style 45 x 45 surface mount box white	82	White RAL 9010	82	50
 N423.520 New	LANmark EU style angled 45 x 45 module 1 Snap-In white	45	White RAL 9010	45	36
 N423.541N	LANmark EU style angled 45 x 45 module 2 Snap-In ivory	45	Ivory	45	36
 N423.540N	LANmark EU style angled 45 x 45 module 2 Snap-In white	45	White RAL 9010	45	36

 = Make to order,  = Make to stock

UK Mounting Hardware for Essential

To support the Essential range of products Nexans has developed a set of UK connecting hardware in Keystone format. For LANmark specific connecting hardware, please refer to "UK Mounting Hardware for LANmark".

Nexans backboxes and cover plates have Euromod dimensions and are common throughout the Essential and LANmark ranges.

Description

- **LJ6 Keystone Module**

LJ6C shuttered module to accommodate one Keystone connector.

- **25 x 50 Keystone Module**

Euromod 25x50mm shuttered module to accommodate one Keystone connector.

Euromod modules fit Nexans single and double gang cover plates.

- **Single and Double Gang Cover Plates**

Available in flat and bevelled version.

- **Single and Double Back Box**



Standards

International ISO/IEC 11801

UK Mounting Hardware for Essential

Product List

☎ = Make to order, 📦 = Make to stock

Nexans ref.	Name
📦 N423.635 New	Essential 86x86 Wallplate 1 Keystone White
📦 N423.630 New	Essential 86x86 Wallplate 2 Keystone White
📦 N423.650	Essential UK style 25x50 module 1 keystone White
📦 N423.640	Essential UK style LJ6C module 1 keystone White
📦 N424.533	UK Back Box - Double Gang
📦 N424.532	UK Back Box - Single Gang
📦 N424.023	UK Cover Plate - Double Gang
📦 N424.531	UK Cover Plate - Double Gang - Bevelled
📦 N424.013	UK Cover Plate - Single Gang
📦 N424.530	UK Cover plate - Single Gang - Bevelled
📦 N424.103	UK Half Blank
📦 N424.003	UK Quarter Blank

☎ = Make to order, 📦 = Make to stock

UK Mounting Hardware for LANmark

To support the LANmark Snap-In range of products Nexans has developed a set of UK connecting hardware. The mounting hardware is common to all performance levels, from LANmark-5 through LANmark-6/6A to LANmark-7/7A.

Description

LJ6 Modular Outlet

LJ6C dimensions (25mm x 37mm) Single Modular shuttered outlets accommodate one Snap-in connector. Supplied in UK White.

25 x 50 Modular Outlet

Single Modular shuttered outlet 25mm x 50mm suitable to accommodate one Snap-in connector. Supplied in UK White.

Modular Outlet fits Nexans single and double gang cover plates.

Single and Double Cover Plates

Single and double gang cover plates supplied in UK White. Flat and beveled version is available.

Single and Double back box

Single and double gang back box supplied in UK White.

Angled modular outlet

The angled modular shuttered outlet 50x50mm can accommodate 2 snap-in connectors and is supplied in UK White. It can be used to create horizontal or vertical quad outlets.



Standards

International ISO/IEC 11801

UK Mounting Hardware for LANmark

Product List

☎ = Make to order, 📦 = Make to stock

Nexans ref.	Name
📦 N423.861 New	LANmark 86x86 Wallplate 1 Snap-In White
📦 N423.862 New	LANmark 86x86 Wallplate 2 Snap-In White
📦 N424.203	LJ6C Angled Module
📦 N424.113	UK 25x50 Flat Module for Snap-ins
📦 N424.204N New	UK Angled 25x50 Module for 1 snap-in
📦 N423.540U	UK Angled Module for 2 snap-ins
📦 N424.533 New	UK Back Box - Double Gang
📦 N424.532 New	UK Back Box - Single Gang
📦 N424.023	UK Cover Plate - Double Gang
📦 N424.531 New	UK Cover Plate - Double Gang - Bevelled
📦 N424.013	UK Cover Plate - Single Gang
📦 N424.530 New	UK Cover plate - Single Gang - Bevelled
📦 N424.103	UK Half Blank
📦 N424.213	UK LJ6C Flat Module for snap-ins
📦 N424.003	UK Quarter Blank

☎ = Make to order, 📦 = Make to stock

US Mounting Hardware for LANmark

- US format
- 45x45 and 45x60 series of Cover Plates, for up to 6 snap-in connectors
- Suitable for fiber and copper
- Includes fixings </>
- All plastic material is UL 94V0
- Colour white

Description

Application

This range of mounting hardware is suitable for US fittings and includes:

- 2 types of cover plates
 - N422.001: 45x45mm inner format, with integrated labelling system
 - N423.001: 60x45mm inner format, with integrated labelling system
- 20x45mm module for 2 snap-in connectors (N421.610)
- 20x45mm blanking module (N420.001)

Detailed information can be found on the corresponding datasheets.

Guarantees

- All plastic material is UL 94V0

Installation

- The cover plates are all supplied with fixing screws.
- All modules can be inserted in the cover plates by a simple click-in mechanism.

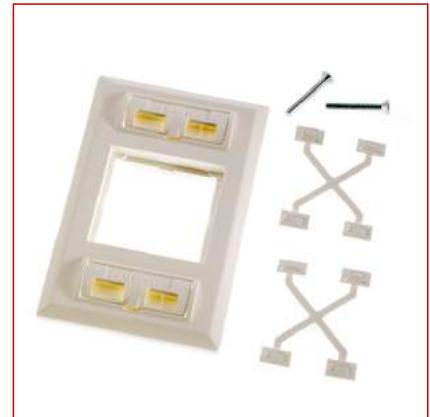

Standards

International UL and CSA approval
National UL 94 V0

US Mounting Hardware for LANmark

Product List

☎ = Make to order, 📦 = Make to stock

Nexans ref.	Name	Width (mm)	Colour	Height (mm)	Depth (mm)
☎ N420.001	45x20 Blanking module for US cover plate	45	White RAL 9010	20	26.5
☎ N421.610	45x20 Module for 2 Snap-in connectors for US cover plate	45	White RAL 9010	20	16.5
📦 N422.001	US Cover plate for 45x45 Outlet with labelling system	70.5	White RAL 9010	115	14
📦 N423.001	US Cover plate for 60x45 Outlet with labelling system	70.5	White RAL 9010	115	14

☎ = Make to order, 📦 = Make to stock

Contact

LAN Systems (Nexans Cabling Solutions)
Phone: +44 (0)1256 486640
ncs.uk@nexans.com

3rd Party Hardware

Description

Nexans have a range of floorplates and adaptors designed to integrate Nexans connectivity into various 3rd party products



Standards

International ISO/IEC 11801

3rd Party Hardware

Product List

☎ = Make to order, 📦 = Make to stock

Nexans ref.	Name	Function of the accessory
📦 N800.305	Snap-In face plate for BTicino Living International range	Adaptator
☎ N800.306	Snap-In face plate for BTicino Light range	Adaptator
☎ N423.110	Plate for up to 6 Snap-In connectors for GES6 Ackermann floor box	Floor Plates
☎ N423.111	Plate for up to 9 Snap-In connectors for GES9 Ackermann floor box	Floor Plates
☎ N423.120	Plate (left part) for up to 6 Snap-In connectors for GB2 Electraplan floor box	Floor Plates
☎ N423.121	Plate (right part) for up to 6 Snap-In connectors for GB2 Electraplan floor box	Floor Plates
☎ N423.122	Plate for up to 9 Snap-In connectors for GB3 Electraplan floor box	Floor Plates
☎ N423.130	Plate for up to 9 Snap-In connectors for GE12 RK5 Obo Bettermann floor box	Floor Plates

☎ = Make to order, 📦 = Make to stock

European Mounting Hardware for Essential Keystone

- European mounting hardware in keystone format
- Designed for Essential-5 and -6 keystone range
- Supplied in glossy white finish
- Also available in UK and US format.

Description

To support the Essential-5 and -6 Keystone range, Nexans has developed specific mounting hardware in keystone format. Please refer to the specific datasheets for keystone modules, frames and blanks.





essential-6



Standards

International ISO/IEC 11801

European Mounting Hardware for Essential Keystone

Product List

Nexans ref.	Name
 N423.645	Essential EU style 22.5 x 45 module 1 Keystone white
 N424.102	Essential EU style 22.5x45 blank module white
 N200.645	Essential EU style 45x45 frame white

 = Make to order,  = Make to stock

US Mounting Hardware for Essential

- US mounting hardware in keystone format
- Designed for Essential-5 and -6 keystone range
- Supplied in textured white finish
- Equipped with labelling windows
- Screws included

Description

To support the Essential Keystone range Nexans has developed specific mounting hardware in keystone format in European, UK and US style.

Please refer to the related product datasheets for the different available modules, frames and blanks in various country specific versions.



essential-6

Standards

International ISO/IEC 11801

US Mounting Hardware for Essential

Product List

Nexans ref.	Name
 N423.622 New	Essential US style Wallplate 2 Keystone Single Gang White
 N423.624 New	Essential US style Wallplate 4 Keystone Single Gang White

☎ = Make to order, 📦 = Make to stock

Contact

LAN Systems (Nexans Cabling Solutions)
Phone: +44 (0)1256 486640
ncs.uk@nexans.com

Voice grade

The Nexans Voice grade includes Voice grade cables and IDC connectivity and is used to integrate telephony applications into a LAN infrastructure.



Contact

LAN Systems (Nexans Cabling Solutions)
Phone: +44 (0)1256 486640
ncs.uk@nexans.com

Voice Cables

- 25pr, 50pr, or 100pr
- Suitable for voice and low grade data
- Category 3 and Category 5 compliant

Description

Voice grade cables are used to integrate telephony applications in the backbone of a LAN infrastructure. They are multipair twisted pair cables and exist in Category 3 and Category 5 performance levels.

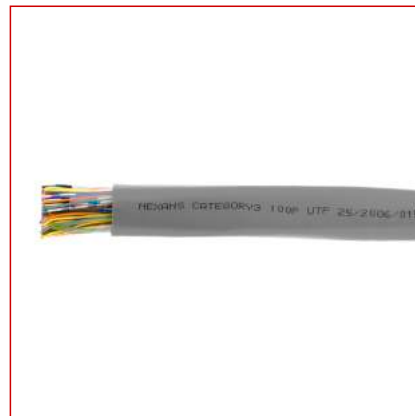

Standards

International ISO/IEC 11801

Voice Cables

Product List

☎ = Make to order, 📦 = Make to stock

Nexans ref.	Name	Number of pairs	Outer sheath	Type of cable	Category
📦 N100.819FR	Voice F/UTP 100 pair AWG24 LSZH Grey 250m reel (LYst)	100	LSZH	F/UTP	Cat. 5
📦 N100.809N	Voice U/UTP 100 pair AWG24 Cat 3 PVC Grey 500m reel	100	PVC	U/UTP	Cat. 3
📦 N100.M02	Voice U/UTP 25 pair AWG24 Cat 5 LSZH Orange 1000m reel	25	LSZH	U/UTP	Cat. 5
📦 N100.M01	Voice U/UTP 25 pair AWG24 Cat 5 PVC Grey 1000m reel	25	PVC	U/UTP	Cat. 5
📦 N100.808N	Voice U/UTP 50 pair AWG24 Cat 3 PVC Grey 500m reel	50	PVC	U/UTP	Cat. 3
📦 N100.M04	Voice U/UTP 50 pair AWG24 Cat 5 LSZH Orange 500m reel	50	LSZH	U/UTP	Cat. 5

☎ = Make to order, 📦 = Make to stock

IDC connectivity and accessories

Complete range of LSA+ voice connectivity and accessories

Description

Nexans offers a complete range of voice IDC module and accessories in order to build a voice backbone in any installation. Nexans uses the LSA+ type connectivity.

The Nexans Voice range includes :

- IDC connection modules
- 19" 3 HU frame
- 3HU patch guide
- Marking cap
- Open contact marking strip
- Surge arrestor and protection magazine
- Patch Cords
- Voice MDF solution : stand alone, wall mounted or wall box
- Accessories and frames

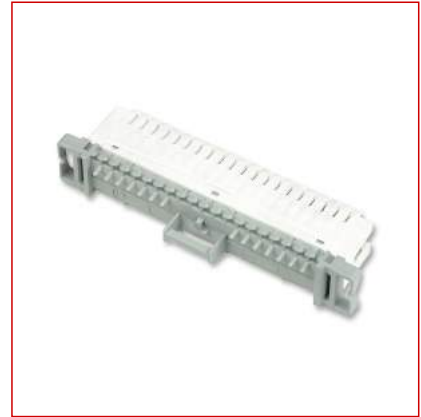

Standards

International ISO/IEC 11801

IDC connectivity and accessories

Product List

☎ = Make to order, 📦 = Make to stock

Nexans ref.	Name
📦 N102.333	10xVoice IDC Label Holder for Module 10 Pairs
📦 N108.106	3HU Patch Guide for IDC Frame
📦 N201.001	IDC 1 pair marking cap red
📦 N103.203	Surge Arrestors
📦 N102.350	Voice 3HU distribution frame for 15 IDC blocks
📦 N102.332	Voice IDC Label Holder for Frame
📦 N102.310	Voice LSA+ Disconnection Module 10 pair
☎ N102.362	Voice MDF 2x26 modules wall box
☎ N102.361	Voice MDF 2x74 modules stand alone (ETSI format)
☎ N102.360	Voice MDF 81 modules wall mounted
📦 N102.321	Voice Surge Protector Magazine for 10 Pairs empty

☎ = Make to order, 📦 = Make to stock

Contact

LAN Systems (Nexans Cabling Solutions)
Phone: +44 (0)1256 486640
ncs.uk@nexans.com

Voice Patch Panels

- High density RJ45 panels for voice applications
- Available in black and in white

Description

Nexans high density Voice Panels are designed to integrate voice circuits in standard structured cabling systems.

- 50 RJ45 ports on 1U
- Mount to standard 19" rack
- LSA/110 punchdown
- Accept multi-pair cables from 22 to 26 AWG
- Supplied with fixings
- Earthing strap included







Standards

International ISO/IEC 11801

Voice Patch Panels

Product List

Nexans ref.	Name
 N500.350BK New	Voice Patch Panel 50 RJ45 2 pair Black
 N500.350	Voice Patch Panel 50 RJ45 2 pair White
 N424.514 To be removed	Voice Patch Panel 50 RJ45 3 pair Black

 = Make to order,  = Make to stock

Contact

LAN Systems (Nexans Cabling Solutions)
Phone: +44 (0)1256 486640
ncs.uk@nexans.com

Voice Patch Cords

- Exists in 3 different types, depending on the application
- Unscreened flexible PVC cable

Description**Application**

Nexans offers 3 different types of patch cords for voice applications, for both in the cabinet and in the work area:

- work area cord: 1 RJ45 to 1 RJ11 (N107.001)
- cabinet patch cords:
 - 1 RJ45 to 1 IDC - 1 pair (N108.165 and N108.166)
 - 1 RJ45 to 1 IDC - 2 pairs (N108.209 and N108.210)

**Standards**

International ISO/IEC 11801

Voice Patch Cords

Product List

☎ = Make to order, 📦 = Make to stock

Nexans ref.	Name	Length (m)
☎ N107.001	Voice 2 pairs Patch Cord RJ45-RJ11 Black 5m	5
📦 N108.165	Voice 1 pair Patch Cord 100 Ohm IDC - RJ45 Grey 1,5m	1.5
📦 N108.166	Voice 1 pair Patch Cord 100 Ohm IDC - RJ45 Grey 3m	3
☎ N108.209	Voice 2 pairs Patch Cord 100 Ohm IDC - RJ45 Grey 1,5m	1.5
☎ N108.210	Voice 2 pairs Patch Cord 100 Ohm IDC - RJ45 Grey 3m	3

☎ = Make to order, 📦 = Make to stock

Tools & Accessories

Contact

LAN Systems (Nexans Cabling Solutions)
Phone: +44 (0)1256 486640
ncs.uk@nexans.com

Tools

Description

Nexans have a complete range of tools for terminating copper systems



Standards

International ISO/IEC 11801

Tools

Product List

☎ = Make to order, 📦 = Make to stock

Nexans ref.	Name
📦 N102.107	Tool - LSA+ IDC punchdown tool
📦 N422.117	Tool - LANmark-7 Easy Termination tool
☎ N422.118	Tool - Set of spare knives for LANmark-7 Easy Termination tool
📦 N420.567	Tool - Universal Comfort tool for Snap-in connector
📦 N808.6000	Universal Termination Tool for 808 connector
📦 N808.6020	360° Connector Crimp Tool for 808 connector
📦 N808.6010	360° Sheath splitting tool for 808 connector
☎ N420.110	Tool - Nexans cable stripper, 110 punchdown tool
📦 N500.120	19" support tray for termination

☎ = Make to order, 📦 = Make to stock

Contact

LAN Systems (Nexans Cabling Solutions)
Phone: +44 (0)1256 486640
ncs.uk@nexans.com

Keystone Clips

- Adaptor clips for LANmark Snap-In connectors

Description

Various clips to turn LANmark Snap-In connectors into Keystone format.









Standards

International ISO/IEC 11801

Keystone Clips

Product List

Nexans ref.	Name
 N429.620	Metal clip for Snap-In to keystone
 N429.625	Red clip for EVO Snap-In connector to keystone format (wall thickness 1,5-1,75 mm)
 N429.626	Blue clip for EVO Snap-In connector to keystone format (wall thickness 2,0-2,25 mm)
 N429.627 New	Yellow clip for EVO Snap-In connector to keystone format (height 19,7 mm)

 = Make to order,  = Make to stock

Contact

LAN Systems (Nexans Cabling Solutions)
Phone: +44 (0)1256 486640
ncs.uk@nexans.com

Retrofit Hoods

Description

A range of coloured patchcord hoods/boots that can be fitted to LANconnect-5e FTP range of cords



Standards

International ISO/IEC 11801

Retrofit Hoods

Product List

☎ = Make to order, 📦 = Make to stock

Nexans ref.	Name
📦 N111.H2S	Hood - LANconnect 5e FTP Black (Pack of 50)
📦 N111.H2B	Hood - LANconnect 5e FTP Blue (Pack of 50)
📦 N111.H2V	Hood - LANconnect 5e FTP Green (Pack of 50)
📦 N111.H2F	Hood - LANconnect 5e FTP Grey (Pack of 50)
📦 N111.H2O	Hood - LANconnect 5e FTP Orange (Pack of 50)
📦 N111.H2R	Hood - LANconnect 5e FTP Red (Pack of 50)
📦 N111.H2J	Hood - LANconnect 5e FTP Yellow (Pack of 50)

☎ = Make to order, 📦 = Make to stock

Pre-terminated Copper

LANmark Pre-Term Bundles

- Ideal assemblies for high density cabling and datacenters
- Bundles available for Jack-Jack or Jack-Plug or Plug-Plug units
- Bundles available for 6, 12 or 24 units
- Cat.6, 6A, 7 or 7A performance supported
- Fully screened and compliant to Alien Crosstalk requirements
- Repeatable and stable level of performance
- Significant reduction of cable laying time
- Bundles are suitable for laying but not pulling operation

Description

Application

LANmark Pre-Term Bundles are assemblies of 6, 12 or 24 pre-terminated units. These can be Jack-Jack, Jack-Plug or Plug-Plug units. These units are maintained together as a bundle through spiral wrapping every meter. LANmark Pre-Term Bundles are well suited for areas where installation time is limited. Bundles of shielded units ensure immunity from Alien Crosstalk and other external interference. Bundles of shielded units do not require on-site testing for Alien Crosstalk since this new parameter is met by design.

Performance

Cat.6/Class E, Cat.6A/Class EA, Cat.7/Class F or Cat.7A/Class FA units can be bundled. Headroom and bandwidth over and above the given category requirements according to the international, European and American standards especially for NEXT/FEXT, Power Sum NEXT/FEXT and Return Loss are guaranteed. When used in combination with LANmark patch cords of the same category the full 100m four-connector links and channels are guaranteed as well.

Installation

Nexans LANmark Pre-Term Bundles help reducing the installation time. One assembly needs to be laid instead of 6, 12 or 24 single cables. Furthermore connectors termination is simply eliminated. Connectors are mounted and tested in our factory.

Nexans LANmark Pre-Term Bundles are designed to be laid and are not suitable for pulling.

All structural hardware items designed for the Snap-In range can be used in all positions of a 4 connector twisted pair cabling channel (PP, CC, CP, TO).

- Fast and straightforward installation
- No need for on-site termination
- Reduction of installation time
- 360° EMC protection and alien crosstalk compliance for shielded products
- Support the 4 connectors channel configuration
- **Numbering on each leg (customizable)**
- **Factory tests in paper or electronic format on request**

Guarantees

Nexans LANmark Pre-Term bundles are covered by a parts and labour warranty as described in the Nexans Certified System Warranty. When installed in combination with LANmark patch cords of the same category, a 25 year channel warranty can be obtained.



Standards

International ISO/IEC 11801:2002/
A2:2008

National TIA/EIA-568-B.2-10

LANmark Pre-Term Bundles

Product List

☎ = Make to order, 📦 = Make to stock

Nexans ref.	Name
☎ N62A.2C21A4XA4X--- New	LANmark-6 Pre-Term Bundle of 6 Cat 6 F1/UTP Solid LSZH Orange Screened Jack Cat 6
☎ N62A.2A21B4XB4X--- New	LANmark-6 Pre-Term Bundle of 6 Cat 6 U/UTP Solid LSZH Orange Unscreened Jack Cat 6
☎ N63A.4G21A6XA6X--- New	LANmark-6A Pre-Term Bundle of 12 Cat 6A F/FTP Solid LSZH Orange Screened Jack Cat 6A
☎ N63A.4C21A6XA6X--- New	LANmark-6A Pre-Term Bundle of 12 Cat 6A F1/UTP Solid LSZH Orange Screened Jack Cat 6A
☎ N63A.4C21A6XXXX--- New	LANmark-6A Pre-Term Bundle of 12 Cat 6A F1/UTP Solid LSZH Orange Screened Single end Jack Cat 6A
☎ N63A.4F11A6XC6X--- New	LANmark-6A Pre-Term Bundle of 12 Cat 6A U/FTP Stranded LSZH Orange Screened Jack-Plug
☎ N63A.4F11CA6XXXX--- New	LANmark-6A Pre-Term Bundle of 12 Cat 6A U/FTP Stranded LSZH Orange Screened Plug
☎ N65A.4F11A6XC6X--- New	LANmark-6A Pre-Term Bundle of 16 Cat 6A U/FTP Stranded LSZH Orange Screened Jack-Plug
☎ N68A.4C21A6XA6X--- New	LANmark-6A Pre-Term Bundle of 18 Cat 6A F1/UTP Solid LSZH Orange Screened Jack Cat 6A
☎ N68A.4C21A6XXXX--- New	LANmark-6A Pre-Term Bundle of 18 Cat 6A F1/UTP Solid LSZH Orange Screened Single end Jack Cat 6A
☎ N64A.4C21A6XA6X--- New	LANmark-6A Pre-Term Bundle of 24 Cat 6A F1/UTP Solid LSZH Orange Screened Jack Cat 6A
☎ N64A.4C21A6XXXX--- New	LANmark-6A Pre-Term Bundle of 24 Cat 6A F1/UTP Solid LSZH Orange Screened Single end Jack Cat 6A
☎ N64A.4F11A6XC6X--- New	LANmark-6A Pre-Term Bundle of 24 Cat 6A U/FTP Stranded LSZH Orange Screened Jack-Plug
☎ N64A.4G21A6XA6X--- New	LANmark-6A Pre-Term Bundle of 2x12 Cat 6A F/FTP Solid LSZH Orange Screened Jack Cat 6A
☎ N62A.4G21A6XA6X--- New	LANmark-6A Pre-Term Bundle of 6 Cat 6A F/FTP Solid LSZH Orange Screened Jack Cat 6A
☎ N62A.4C21A6XA6X--- New	LANmark-6A Pre-Term Bundle of 6 Cat 6A F1/UTP Solid LSZH Orange Screened Jack Cat 6A
☎ N62A.4C21A6XXXX--- New	LANmark-6A Pre-Term Bundle of 6 Cat 6A F1/UTP Solid LSZH Orange Screened Single end Jack Cat 6A
☎ N62A.4F11A6XC6X--- New	LANmark-6A Pre-Term Bundle of 6 Cat 6A U/FTP Stranded LSZH Orange Screened Jack-Plug
☎ N62A.4F11C6XXXX--- New	LANmark-6A Pre-Term Bundle of 6 Cat 6A U/FTP Stranded LSZH Orange Screened Plug
☎ N67A.4C21A6XA6X--- New	LANmark-6A Pre-Term Bundle of 8 Cat 6A F1/UTP Solid LSZH Orange Screened Jack Cat 6A
☎ N64A.6H21A8XA8X--- New	LANmark-7A Pre-Term Bundle of 24 Cat 7A S/FTP Solid LSZH Orange Screened Jack Cat 7A

☎ = Make to order, 📦 = Make to stock

Selling delivery information

Nexans LANmark Pre-Term Bundles can be ordered in any length up to 90m. Please refer to Nexans Design Guidelines for length calculations and limitations according to the standards. Individual packaging in boxes (L <30m) or one way reel (L >30m). Customized packaging on demand.

LANmark Pre-Term Units

- Pre-Term units available in Jack-Jack or Jack-Plug or Plug-Plug assemblies
- Cat.6, 6A, 7 or 7A performance supported
- Repeatable and stable level of performance
- Significant reduction of cable laying time

Description

Application

LANmark Pre-Term pre-terminated units can be Jack-Jack, Jack-Plug or Plug-Plug assemblies. LANmark Pre-Term units are well suited for areas where installation time is limited. Shielded units ensure immunity from electromagnetic interferences and do not require on-site testing for Alien Crosstalk since this new parameter is met by design.

Performance

Cat.6/Class E, Cat.6A/Class EA, Cat.7/Class F or Cat.7A/Class FA units can be made. Headroom and bandwidth over and above the given category requirements according to the international, european and american standards especially for NEXT/FEXT, Power Sum NEXT/FEXT and Return Loss are guaranteed. When used in combination with LANmark patch cords of the same category the full 100m four-connector links and channels are guaranteed as well.

Installation

Nexans LANmark Pre-Term Units help reducing the installation time since connectors termination is simply eliminated. Connectors are mounted and tested in our factory.

Nexans LANmark Pre-Term Units are designed to be laid and are not suitable for pulling.

All structural hardware items designed for the Snap-In range can be used in all positions of a 4 connector twisted pair cabling channel (PP, CC, CP, TO).

- Fast and straight forward installation
- No need for on-site termination
- Reduction of installation time
- 360° EMC protection and alien crosstalk compliance for shielded products
- Support the 4 connectors channel configuration
- **Numbering on each Unit (customizable)**
- **Factory tests in paper or electronic format on request**

Guarantees



Nexans LANmark Pre-Term Units are covered by a parts and labour warranty as described in the Nexans Certified System Warranty. When installed in combination with LANmark patch cords of the same category, a 25 year channel warranty can be obtained.

Standards

International ISO/IEC 11801

LANmark Pre-Term Units

Product List

Nexans ref.	Name
 N61A.2C21A4XA4X--- New	LANmark-6 Pre-Term Cat 6 F1/UTP Solid LSZH Orange Screened Jack Cat 6 unit
 N61B.4G21A6XA6X--- New	LANmark-6A Pre-Term 2x4 Pair Cat 6A F/FTP Solid LSZH Orange Screened Jack Cat 6A unit
 N61A.4F11A6XC6X--- New	LANmark-6A Pre-Term Cat 6A U/FTP Stranded LSZH Orange Screened Jack-Plug Cat 6A unit

☎ = Make to order, 📦 = Make to stock

Selling delivery information

Nexans LANmark Pre-Term Units can be ordered in any length up to 90m. Please refer to Nexans Design Guidelines for length calculations and limitations according to the standards. Individual packaging in boxes (L <30m) or one way reel (L>30m). Customized packaging on demand.

LANmark-6A Pre-Term Multipair Cat 6A RJ45 Jack-Jack

- Ideal assemblies for 10GBase-T applications and datacenters
- Fully compliant to the new Category 6A and Class EA standards
- Guaranteed performance in 2, 3 or 4 connectors channels up to 500MHz
- Very short distances for datacenters supported
- Fully screened and compliant to Alien Crosstalk requirements
- Enable fast installation and eliminate field termination
- Repeatable and stable level of performance

Description

Application

LANmark-6A Pre-Term Category 6A U/FTP solid LSZH orange screened Jack Category 6A assemblies have been designed specifically to support the higher frequencies required for 10 Gigabit Ethernet, while maintain to be fully backwards compatible with today's needs. All LANmark-6A products making the assemblies are screened to ensure immunity from Alien Crosstalk and other external interference and are specified up to frequencies of 500MHz. LANmark-6A EVO jacks use a fully closed rear cover providing 360° screening and excellent coupling attenuation. The Multipair cable is made of individually screened pairs assembled in several 4 pair units. These LANmark-6A Pre-Term Category 6A assemblies do not required on-site testing for Alien Crosstalk since this new 10G parameter is met by design.

- 10Base-T Ethernet
- 100Base-TX Fast Ethernet
- 1000Base-TX Gigabit Ethernet
- 10GBase-T 10 Gigabit Ethernet IEEE 802.3an
- 155 Mbit ATM
- 1.2 Gbit ATM
- future Cat 6A and Class EA applications

Performance

With guaranteed performance to 500MHz, Nexans LANmark-6A Pre-Term Category 6A assemblies provide guaranteed headroom and bandwidth over and above the Category 6A / Class EA requirements of international, european and american standards especially for NEXT/FEXT, Power Sum NEXT/FEXT and Return Loss. When used in combination with LANmark-6A patch cords, the system supports the 10GBase-T applications as defined in IEEE 802.3an, and the full 100m four-connector links and channels meet Category 6A and Class EA requirements as defined in TIA/EIA568B.2 Addendum 10 and ISO/IEC11801 2002/A1:2008. This enables to achieve high performing 4 connectors channels as well as very short link and channel configurations needed in data centres with up to 3 connection points within 12 meters.

Installation

Nexans LANmark-6A Pre-Term Category 6A assemblies have the advantage of offering significantly smaller dimensions and reduced weight compared to the equivalent standard 4 pair cables. They also provide a significant installation advantage. Cable pulling is reduced to one unit. Connectors termination is simply eliminated.

All structural hardware items designed for the EVO Snap-In range can be used in all positions of a 4 connector twisted pair cabling channel (PP, CC, CP, TO).



Standards

International EN 50173-5;
 IEEE 802.3an; ISO/IEC 11801:2002/
 A2:2008; ISO/IEC 24764
National TIA/EIA-568-B.2-10; TIA/
 EIA-942

LANmark-6A Pre-Term Multipair Cat 6A RJ45 Jack-Jack



- Fast and straight forward installation
- No need for on-site termination
- 360° EMC protection and alien crosstalk compliance
- Support the 4 connectors channel configuration
- Support short links
- Designed for datacentres
- **Numbering on each leg (customizable)**
- **Factory tests in paper or electronic format on request**

Guarantees

Nexans LANmark-6A Pre-Term Category 6A assemblies are covered by a parts and labour warranty as described in the Nexans Certified System Warranty. When installed in combination with LANmark-6A patch cords, a 25 year channel warranty can be obtained covering full 10GBase-T support and full Cat 6A/Class EA compliance.

LANmark-6A Pre-Term Multipair Cat 6A RJ45 Jack-Jack

Product List

Nexans ref.	Name
 N61C.4F21A6XA6X--- New	LANmark-6A Pre-Term Multipair 3x4 pair Cat 6A U/FTP Solid LSZH Orange Screened Jack Cat 6A
 N61D.4F21A6XA6X--- New	LANmark-6A Pre-Term Multipair 4x4 pair Cat 6A U/FTP Solid LSZH Orange Screened Jack Cat 6A
 N61E.4F21A6XA6X--- New	LANmark-6A Pre-Term Multipair 6x4 pair Cat 6A U/FTP Solid LSZH Orange Screened Jack Cat 6A

☎ = Make to order, 📦 = Make to stock

Electrical Performance LANmark-6A 4 Connector Channel Part 1

"All values are based on Worst Case 4 Connector Channel configurations according ISO11801:2008 AM1 Minimal and maximum values represent guaranteed channel performance"

Freq in MHz	Attn in dB		NEXT in dB			PSNEXT in dB			ACR-F in dB	
	Max	Typ	Std	Min	Typ	Std	Min	Typ	Std	Typ
1	<4	4.0	65.0	67.0	85.0	62.0	64.0	74.8	63.3	69.9
4	4.1	4.1	63.0	65.0	72.9	60.5	62.5	65.0	51.2	57.9
10	6.4	6.3	56.6	58.6	65.0	54.0	56.0	58.5	43.3	49.9
16	8.1	8.0	53.2	55.2	60.9	50.6	52.6	55.1	39.2	45.9
20	9.1	9.0	51.6	53.6	59.0	49.0	51.0	53.5	37.2	43.9
31.25	11.4	11.2	48.4	50.4	55.1	45.7	47.7	50.2	33.4	40.0
62.5	16.3	15.9	43.4	45.4	49.1	40.6	42.6	45.1	27.3	34.0
100	20.8	20.2	39.9	41.9	45.0	37.1	39.1	41.6	23.3	29.9
155	26.2	25.4	36.7	38.7	41.2	33.8	35.8	38.3	19.5	26.1
200	30.0	28.9	34.8	36.8	39.0	31.9	33.9	36.4	17.2	23.9
250	33.8	32.5	33.1	35.1	37.0	30.2	32.2	34.7	15.3	22.0
300	37.3	35.7	31.7	33.7	35.4	28.8	30.8	33.3	13.7	20.4
500	49.3	46.7	27.9	29.9	31.0	24.8	26.8	24.9	9.3	16.0

*Standard values based on ISO11801:2002/A1:2008 ClassEA

LANmark-6A Pre-Term Multipair Cat 6A RJ45 Jack-Jack

Electrical Performance LANmark-6A 4 Connector Channel Part 2

All values are based on Worst Case 4 Connector Channel configurations according to ISO11801:2008 AM1. Minimal and maximum values represent guaranteed channel performance.

Freq in MHz	PS ACR-F in dB		PS ANEXT in dB			PS AACR-F in dB			RL in dB		
	Std	Typ	Std	Min	Typ	Std	Min	Typ	Std	Min	Typ
1	60.3	66.9	80.0	90.0	92.0	77.0	92.0	94.0	19.0	21.0	21.0
4	48.2	54.9	74.0	89.0	91.0	65.0	80.0	82.0	19.0	21.0	32.0
10	40.3	46.9	70.0	85.0	87.0	57.0	72.0	74.0	19.0	21.0	28.0
16	36.2	42.9	68.0	83.0	85.0	52.9	67.9	69.9	18.0	20.0	26.0
20	34.2	40.9	67.0	82.0	84.0	51.0	66.0	68.0	17.5	19.5	25.0
31.25	30.4	37.0	65.1	80.1	82.1	47.1	62.1	64.1	16.5	18.5	23.1
62.5	24.3	31.0	62.0	77.0	79.0	41.1	56.1	58.1	14.0	16.0	20.0
100	20.3	26.9	60.0	75.0	77.0	37.0	52.0	54.0	12.0	14.0	18.0
155	16.5	23.1	57.1	72.1	74.1	33.2	48.2	50.2	10.1	12.1	16.1
200	14.2	20.9	55.5	70.5	72.5	31.0	46.0	48.0	9.0	11.0	15.0
250	12.3	19.0	54.0	69.0	71.0	29.0	44.0	46.0	8.0	10.0	14.0
300	10.7	17.4	52.8	67.8	69.8	27.5	42.5	44.5	8.0	10.0	13.2
500	6.3	13.0	49.5	64.5	66.5	23.0	38.0	40.0	8.0	10.0	11.0

*Standard values based on ISO11801:2002/A1:2008 ClassEA

Selling delivery information

Nexans LANmark-6A Pre-Term Category 6A assemblies can be ordered in any length up to 90m. Please refer to Nexans Design Guidelines for length calculations and limitations according to the standards. Individual packaging in boxes (L <30m) or one way reel (L >30m). Customized packaging on demand.

Optical Fibre

A full spectrum of Nexans LANmark fiber solutions is available for various performance levels and constructions to meet different applications and environmental conditions. LANmark fibre solutions approach offers flexibility and scalability for campus and building backbones, horizontal cabling applications, device termination in data centers and storage area networks.

Nexans fibre solutions are a fully integrated element of our LAN systems and covered within the system warranty.

The range includes:

- Cables
- Connectivity
- Hardware
- Pre-Terminated Fibre Assemblies



Fibre Cables

A wide variety of cable designs and fibre grade are available, meeting the needs of each mission critical applications. Designed for high performance and scalability for LAN, SAN and Campus applications, LANmark-OF technology deliver premium performance and reliability.

A large number of constructions are available: Tight / loose construction, PE / LSZH., rodent resistant / dielectric, ...

- UT
- UC
- UD
- TB
- TBW+
- ZC



In addition, Nexans proposes the best cost effective solution. 7 different fibre grades are available to best address the level of performance required.p>

LANmark-OF 1, OF 2 & OF sm

Standard Multimode & Singlemode performance. LANmark-OF 1 is the MM62.5 version, LANmark-OF 2 the MM50 version, LANmark-OF sm the singlemode version.

LANmark-OF 1xt & OF 2xt

Laser optimised, enhanced OM1 & OM2 respectively (50/125 & 62.5/125) fibre cables designed to provide extended distances for Gigabit applications.

LANmark-OF 3 & OF 3xt

OM3 compliant 50/125 for 10 Gigabit applications up to 300m and up to 450m respectively..

EIA Fibre Colour Table

EIA Fibre Colour Coding					
Fibre	Colour		Fibre	Colour	
1	Blue		13	Blue + 1 ring	
2	Orange		14	Orange + 1 ring	
3	Green		15	Green + 1 ring	
4	Brown		16	Brown + 1 ring	
5	Grey		17	Grey + 1 ring	
6	White		18	White + 1 ring	
7	Red		19	Blue + 2 rings	
8	Black		20	Orange + 2 rings	
9	Yellow		21	Green + 2 rings	
10	Violet		22	Brown + 2 rings	
11	Pink		23	Grey + 2 rings	
12	Turquoise		24	White + 2 rings	

Optical cable specifications

- Full range of standard compliant multimode cables
- Singlemode OS2 cables

Description

LANmark-OF OM3 and OM4: Fibre cables with high performance multimode fibres for 10, 40 and 100 Gb/s Ethernet LAN applications

LANmark-OF OM3 and OM4 from Nexans Cabling Solutions offers fully OM3 and OM4 standard compliant multimode fibres. LANmark-OF OM3 and OM4 ensures highest bandwidth performance for Premises, Local Area Network (LAN) and Storage Area Network (SAN) while its optimised design for low-cost 850 nm lasers (VCSEL) contributes to overall system cost reduction.

The low attenuation values of 3.0 dB/km @ 850 nm exceed the requirements of the ISO/IEC 11801 standard. The superior geometric tolerances compared to the fibre standard reduce the connector loss due to improved coupling from the light. The effective modal bandwidth is measured with the most stringent DMD characterisation methods: LANmark-OF cables are measured against both the Effective Modal Bandwidth Calculated (EMBc) method and the mask templates standard.



LANmark-OF

Standards

International ISO/IEC 11801

LANmark-OF OM3: Key performance characteristics

- Guarantees reliable system performance for 10 Gb/s Ethernet serial transmission over 330 m.
- Guarantees reliable system performance for 40 Gb/s and 100 Gb/s Ethernet transmission over 100 m.
- Guaranteed OM3 compliance: Effective Modal Bandwidth (EMB) of 2000 Mhz.km, Overfilled Launch Bandwidth (OFL) of 1500 Mhz.km @ 850 nm and 500 Mhz.km @ 1300 nm.
- Compliant to IEC 60793-2-10 as fibre type A1a.2

LANmark-OF OM4: Key performance characteristics

- Guarantees reliable system performance for 10 Gb/s Ethernet serial transmission over 550 m
- Guarantees reliable system performance for 40 Gb/s and 100 Gb/s Ethernet transmission over 150 m with LANmark-OF low loss connectivity.
- Guaranteed OM4 compliance: Effective Modal Bandwidth (EMB) of 4700 Mhz.km, Overfilled Launch Bandwidth (OFL) of 3500 Mhz.km @ 850 nm and 500 Mhz.km @ 1300 nm.
- Compliant to IEC 60793-2-10 as fibre type A1a.3

Standardization and compliances for LANmark-OF OM3 and LANmark-OF OM4

- IEC 60793-1-49: differential mode delay (DMD) to measure effective modal bandwidth (EMB)
- IEC 60793-1-41: overfilled mode launch bandwidth (OFL BW)
- ISO/IEC 11801 (2) as OM3 and OM4 fibre
- IEC 60793-2-10 as fibre type A1a.2 for LANmark-OF OM3
- IEC 60793-2-10 as fibre type A1a.3 for LANmark-OF OM4

LANmark-OF OS2 Singlemode cables with low water peak singlemode fibre (G.652.D)

Optical cable specifications

Singlemode OS2 cables from Nexans Cabling Solution are cables with full spectrum fibres and provide enhanced performance across the entire 1260 nm to 1625 nm wavelength range. Due to its long-term low attenuation at the 1383 nm water peak region the fibres allow operation in the expanded band (wavelength across 1360 to 1480 nm).

Its full-spectrum capability allows use of lasers for DWDM and CWDM technologies. LANmark-OF OS2 Singlemode cables have low attenuation values across the entire wavelength range. They are full compatibility and interoperability with the installed fibre base, including standard singlemode fibre according to ITU-T G652A, B and C.

Standardization and compliances for LANmark-OF Singlemode OS2

- ITU-T as fibre type G.652.D
- Singlemode OS2 cable defined in ISO/IEC 11801 amendment 2
- IEC 60793-1
- IEC 60793-2-50 as fibre type B1.3

LANmark-OF OM3 and OM4: Optical Performance

Characteristics	OM3 Spec Values	OM4 Spec Values	Unit
Bandwidth (Overfilled Launch) 850 nm	≥ 1500	≥ 3500	Mhz.km
Bandwidth (Overfilled Launch) 1300 nm	≥ 500	≥ 500	Mhz.km
Effective Modal Bandwidth (EMB) 850 nm	≥ 2000	≥ 4700	Mhz.km
Transmission link lengths for 1 Gb/s (SX/LX)	880/550	900/550	m
Transmission link lengths for 10 Gb/s (SR/LX4)	330/300	550*/300	m
Transmission link lengths for 40 Gb/s (SR4)	100	150*	m
Transmission link lengths for 100 Gb/s (SR10)	100	150*	m
Attenuation 850 nm	3.0	3.0	dB/km
Attenuation 1300 nm	1.0	1.0	dB/km
Attenuation uniformity	≤ 0.2	≤ 0.2	dB
Numerical Aperture	0.20 ± 0.02	0.20 ± 0.02	

* with engineered link of maximum 1.0 dB connector insertion loss

LANmark-OF OM3 and OM4: Geometrical Characteristics

Characteristic	Spec Values	Unit
Core Diameter	50 ± 2.5	µm
Core Non-Circularity	≤ 6.0	%
Core/Clad Concentricity	≤ 1.5	µm
Cladding Diameter	125 ± 1.0	µm
Cladding Non-Circularity	≤ 1.0	%
Coating Diameter	250 ± 15.0	µm
Coating/Clad Concentricity Error	≤ 10.0	µm

Optical cable specifications

LANmark-OF OS2 Singlemode cables: Optical Performance

Characteristics	Spec Values	Unit
Fibre type	G.652.D	
Transmission link length for 1000Base-LX	5000	m
Transmission link length for 10GBase-LR	10000	m
Transmission link length for 10GBase-LX4	10000	m
Transmission link length for 10Gbit-FC	10000	m
Attenuation 1300 nm	0.40	dB/km
Attenuation 1385 nm	0.40	dB/km
Attenuation 1550 nm	0.28	dB/km
Attenuation uniformity	≤ 0.2	dB
Cut-off wavelength	1150 - 1330	nm
Dispersion 1285-1330 nm	≤ 3.5	ps/nm.km
Dispersion 1550 nm	≤ 18	ps/nm.km
Zero dispersion	1310 ± 10	nm
Dispersion mode polarisation	≤ 0.2	ps/√km

LANmark-OF Singlemode OS2 cables: Geometrical Characteristics

Characteristic	Spec Values	Unit
Mode Field Diameter	9.2 ± 0.5	µm
Cladding Diameter	125 ± 1.0	µm
Coating Diameter	245 ± 10.0	µm
Core Non-Circularity	≤ 6.0	%
Cladding Non-Circularity	≤ 2.0	%
Proof test	100	psi

LANmark-OF Tight Buffer Indoor

- Tight Buffer Indoor optical fibre cable
- Indoor cable
- Aramid yarns for ease of installation
- Designed for direct termination and splicing
- Up to 24 fibres and available in all fibre grades

Description

Description and Application

The LANmark-OF Tight buffer Indoor has 900 um buffered fibres. This second coating till 900 um provides additional protection of the fibres and facilitates the handling when terminating the fibres in a patch panel. The easy strip tight buffer design allows stripping the fibre over 10 cm in one action.

The LANmark-OF Tight buffer Indoor is most suitable for direct termination by either anaerobic or hot melt connectors. The tight buffered fibres can also be terminated with splicing of pigtails.

The dry structure of the LANmark-Of Tight Buffer Indoor allows both vertical and horizontal installations. It complies with the indoor fire requirements. The cables can also be installed in a duct by pulling.

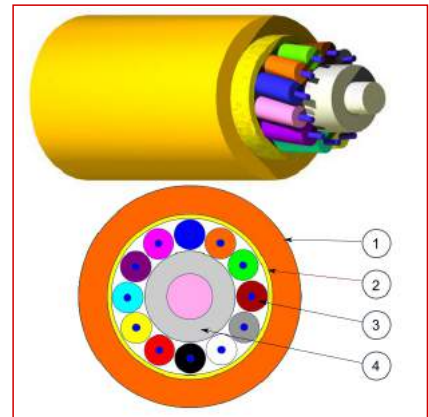

LANmark-OF

Standards

International ISO/IEC 11801

Construction

Legend accompanying the cross section drawing:

1. Outer sheath in LSZH material
2. Aramid Yarns
3. Optical fibre (900 um)
4. Central Strength element (not for 2 fibres)

Characteristics

- Designed for direct termination and splicing
- Indoor cable for horizontal and vertical installations
- Dielectric design
- Flame retardant (IEC 60332-1)
- Fire retardant (IEC 60332-3)
- Aramid yarns for ease of handling and as strength element
- Available in all fibre grades
- Available till 24 fibres



Mechanical resistance to impacts
100 impacts of 1 N.m



Flame retardant
IEC 60332-1



Fire retardant
IEC 60332-3



Ambient installation temperature, range
0 .. 40 °C



Operating temperature, range
-20 .. 60 °C

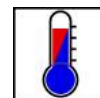

Storage temperature, range
-40 .. 60 °C

LANmark-OF Tight Buffer Indoor

Characteristics

Mechanical characteristics	
Mechanical resistance to impacts	100 impacts of 1 N.m
Crush resistance (IEC 60794-1-E3)	100 N/cm
Usage characteristics	
Flame retardant	IEC 60332-1
Fire retardant	IEC 60332-3
Ambient installation temperature, range	0 .. 40 °C
Operating temperature, range	-20 .. 60 °C
Storage temperature, range	-40 .. 60 °C

Mechanical and Dimensional Characteristics for Tight Buffer Indoor

Nb optical fibres	Nom. outer diam. [mm]	Approx. weight [kg/km]	static bending rad. [mm]	Min. dynamic operating bending rad. [mm]	Maximum pulling force (IEC 60794-1-2-E1) [N]	Maximum operating pulling force [N]
2	4.7	17	35	100.0	800	400
4	4.6	24	45	100.0	700	200
6	4.6	24	45	100.0	700	200
8	5.3	33	70	110.0	1200	300
12	6.6	48	70	135.0	1200	300
24	7.3	60	75	150.0	1900	550

N-numbers for Tight Buffer Indoor

Fiber optic type	Nexans ref.	Name
OM1 62.5/125	N160.TBIN02	LANmark-OF Tight Buffer Indoor 2x Multimode 62,5/125 OM1 LSZH Orange
OM1 62.5/125	N160.TBIN04	LANmark-OF Tight Buffer Indoor 4x Multimode 62,5/125 OM1 LSZH Orange
OM1 62.5/125	N160.TBIN06	LANmark-OF Tight Buffer Indoor 6x Multimode 62,5/125 OM1 LSZH Orange
OM1 62.5/125	N160.TBIN08	LANmark-OF Tight Buffer Indoor 8x Multimode 62,5/125 OM1 LSZH Orange
OM1 62.5/125	N160.TBIN12	LANmark-OF Tight Buffer Indoor 12x Multimode 62,5/125 OM1 LSZH Orange
OM1 62.5/125	N160.TBIN24	LANmark-OF Tight Buffer Indoor 24x Multimode 62,5/125 OM1 LSZH Orange
OM2 50/125	N162.TBIN02	LANmark-OF Tight Buffer Indoor 2x Multimode 50/125 OM2 LSZH Orange
OM2 50/125	N162.TBIN04	LANmark-OF Tight Buffer Indoor 4x Multimode 50/125 OM2 LSZH Orange
OM2 50/125	N162.TBIN06	LANmark-OF Tight Buffer Indoor 6x Multimode 50/125 OM2 LSZH Orange
OM2 50/125	N162.TBIN08	LANmark-OF Tight Buffer Indoor 8x Multimode 50/125 OM2 LSZH Orange
OM2 50/125	N162.TBIN12	LANmark-OF Tight Buffer Indoor 12x Multimode 50/125 OM2 LSZH Orange
OM2 50/125	N162.TBIN24	LANmark-OF Tight Buffer Indoor 24x Multimode 50/125 OM2 LSZH Orange
OM3 50/125	N165.TBIN02	LANmark-OF Tight Buffer Indoor 2x Multimode 50/125 OM3 LSZH Orange
OM3 50/125	N165.TBIN04	LANmark-OF Tight Buffer Indoor 4x Multimode 50/125 OM3 LSZH Orange
OM3 50/125	N165.TBIN06	LANmark-OF Tight Buffer Indoor 6x Multimode 50/125 OM3 LSZH Orange
OM3 50/125	N165.TBIN08	LANmark-OF Tight Buffer Indoor 8x Multimode 50/125 OM3 LSZH Orange
OM3 50/125	N165.TBIN12	LANmark-OF Tight Buffer Indoor 12x Multimode 50/125 OM3 LSZH Orange
OM3 50/125	N165.TBIN24	LANmark-OF Tight Buffer Indoor 24x Multimode 50/125 OM3 LSZH Orange
OM4 50/125	N167.TBIN02	LANmark-OF Tight Buffer Indoor 2x Multimode 50/125 OM4 LSZH Orange
OM4 50/125	N167.TBIN04	LANmark-OF Tight Buffer Indoor 4x Multimode 50/125 OM4 LSZH Orange
OM4 50/125	N167.TBIN06	LANmark-OF Tight Buffer Indoor 6x Multimode 50/125 OM4 LSZH Orange
OM4 50/125	N167.TBIN08	LANmark-OF Tight Buffer Indoor 8x Multimode 50/125 OM4 LSZH Orange
OM4 50/125	N167.TBIN12	LANmark-OF Tight Buffer Indoor 12x Multimode 50/125 OM4 LSZH Orange
OM4 50/125	N167.TBIN24	LANmark-OF Tight Buffer Indoor 24x Multimode 50/125 OM4 LSZH Orange

LANmark-OF Tight Buffer Indoor

Fiber optic type	Nexans ref.	Name
SM (G.652D)	N164.TBIN02	LANmark-OF Tight Buffer Indoor 2x Singlemode 9/125 OS2 LSZH Yellow
SM (G.652D)	N164.TBIN04	LANmark-OF Tight Buffer Indoor 4x Singlemode 9/125 OS2 LSZH Yellow
SM (G.652D)	N164.TBIN06	LANmark-OF Tight Buffer Indoor 6x Singlemode 9/125 OS2 LSZH Yellow
SM (G.652D)	N164.TBIN08	LANmark-OF Tight Buffer Indoor 8x Singlemode 9/125 OS2 LSZH Yellow
SM (G.652D)	N164.TBIN12	LANmark-OF Tight Buffer Indoor 12x Singlemode 9/125 OS2 LSZH Yellow
SM (G.652D)	N164.TBIN24	LANmark-OF Tight Buffer Indoor 24x Singlemode 9/125 OS2 LSZH Yellow

LANmark-OF Tight Buffer Universal

- Tight Buffer Universal optical fibre cable
- Indoor cable and outdoor installation in a duct
- Fully waterproof and rodent retardant
- Designed for direct termination and splicing
- Up to 24 fibres and available in all fibre grades

Description

Description and Application

The LANmark-OF Tight buffer Universal has 900 um buffered fibres. This second coating till 900 um provides additional protection of the fibres and facilitates the handling when terminating the fibres in a patch panel. The easy strip tight buffer design allows stripping the fibre over 10 cm in one action.

The LANmark-OF Tight buffer Universal is most suitable for direct termination by either anaerobic or hot melt connectors. The tight buffered fibres can also be terminated with splicing of pigtails.

The dry structure of the LANmark-Of Tight Buffer Universal allows both vertical and horizontal installations. It complies with the indoor fire requirements. The cables can also be installed in a duct by pulling.

The LANmark-OF Tight Buffer Universal can be used for outdoor installation in a duct: the water tight glass yarns make the cables fully waterproof and rodent resistant.

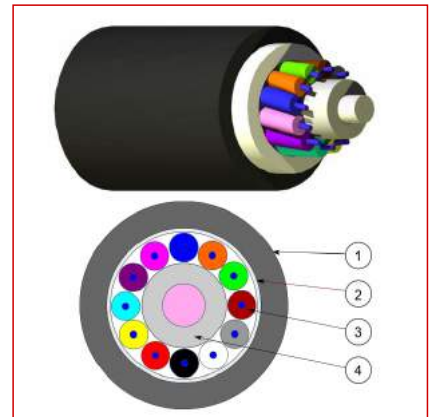

LANmark-OF

Standards

International ISO/IEC 11801

Construction

Legend accompanying the cross section drawing:

1. LSZH outer sheath with UV resistant additive
2. Watertight glass yarns
3. Optical fibres (900 um)
4. Central strength element

Characteristics

- Designed for direct termination and splicing
- Dielectric design
- Indoor cable for horizontal and vertical installations
- Flame retardant (IEC 60332-1) and fire retardant (IEC 60332-3)
- Outdoor cable for installation in a duct
- Fully waterproof
- Rodent resistant
- UV resistant
- Available in all standard compliant fibre grades
- Available till 24 fibres



Mechanical resistance to impacts
100 impacts of 1 N.m



Flame retardant
IEC 60332-1



Fire retardant
IEC 60332-3



Ambient installation temperature, range
0 .. 40 °C



Operating temperature, range
-40 .. 70 °C

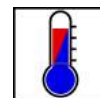

Storage temperature, range
-40 .. 70 °C

LANmark-OF Tight Buffer Universal

Characteristics

Mechanical characteristics	
Mechanical resistance to impacts	100 impacts of 1 N.m
Crush resistance (IEC 60794-1-E3)	100 N/cm
Usage characteristics	
Flame retardant	IEC 60332-1
Fire retardant	IEC 60332-3
Ambient installation temperature, range	0 .. 40 °C
Operating temperature, range	-40 .. 70 °C
Storage temperature, range	-40 .. 70 °C

Mechanical and Dimensional Characteristics for Tight Buffer Universal

Number of optical fibres	4	6	8	12	24	
Nominal outer diameter	5.7	5.7	6.5	7.5	10.6	mm
Approximate weight	38	38	47	68	135	kg/km
Minimum static operating bending radius	90	90	100	120	160	mm
Minimum dynamic operating bending radius	120.0	120.0	130.0	150.0	210.0	mm
Maximum pulling force (IEC 60794-1-2-E1)	1000	1000	1300	1700	2300	N
Maximum operating pulling force	300	300	400	500	550	N

N-numbers for Tight Buffer Universal

Fiber optic type	Nexans ref.	Name
OM1 62.5/125	N160.TBUN04	LANmark-OF Tight Buffer Universal 4x Multimode 62,5/125 OM1 LSZH Black
OM1 62.5/125	N160.TBUN06	LANmark-OF Tight Buffer Universal 6x Multimode 62,5/125 OM1 LSZH Black
OM1 62.5/125	N160.TBUN08	LANmark-OF Tight Buffer Universal 8x Multimode 62,5/125 OM1 LSZH Black
OM1 62.5/125	N160.TBUN12	LANmark-OF Tight Buffer Universal 12x Multimode 62,5/125 OM1 LSZH Black
OM1 62.5/125	N160.TBUN24	LANmark-OF Tight Buffer Universal 24x Multimode 62,5/125 OM1 LSZH Black
OM2 50/125	N162.TBUN04	LANmark-OF Tight Buffer Universal 4x Multimode 50/125 OM2 LSZH Black
OM2 50/125	N162.TBUN06	LANmark-OF Tight Buffer Universal 6x Multimode 50/125 OM2 LSZH Black
OM2 50/125	N162.TBUN08	LANmark-OF Tight Buffer Universal 8x Multimode 50/125 OM2 LSZH Black
OM2 50/125	N162.TBUN12	LANmark-OF Tight Buffer Universal 12x Multimode 50/125 OM2 LSZH Black
OM2 50/125	N162.TBUN24	LANmark-OF Tight Buffer Universal 24x Multimode 50/125 OM2 LSZH Black
OM3 50/125	N165.TBUN04	LANmark-OF Tight Buffer Universal 4x Multimode 50/125 OM3 LSZH Black
OM3 50/125	N165.TBUN06	LANmark-OF Tight Buffer Universal 6x Multimode 50/125 OM3 LSZH Black
OM3 50/125	N165.TBUN08	LANmark-OF Tight Buffer Universal 8x Multimode 50/125 OM3 LSZH Black
OM3 50/125	N165.TBUN12	LANmark-OF Tight Buffer Universal 12x Multimode 50/125 OM3 LSZH Black
OM3 50/125	N165.TBUN24	LANmark-OF Tight Buffer Universal 24x Multimode 50/125 OM3 LSZH Black
OM4 50/125	N167.TBUN04	LANmark-OF Tight Buffer Universal 4x Multimode 50/125 OM4 LSZH Black
OM4 50/125	N167.TBUN06	LANmark-OF Tight Buffer Universal 6x Multimode 50/125 OM4 LSZH Black
OM4 50/125	N167.TBUN08	LANmark-OF Tight Buffer Universal 8x Multimode 50/125 OM4 LSZH Black
OM4 50/125	N167.TBUN12	LANmark-OF Tight Buffer Universal 12x Multimode 50/125 OM4 LSZH Black
OM4 50/125	N167.TBUN24	LANmark-OF Tight Buffer Universal 24x Multimode 50/125 OM4 LSZH Black
SM (G.652D)	N164.TBUN04	LANmark-OF Tight Buffer Universal 4x Singlemode 9/125 OS2 LSZH Black
SM (G.652D)	N164.TBUN06	LANmark-OF Tight Buffer Universal 6x Singlemode 9/125 OS2 LSZH Black
SM (G.652D)	N164.TBUN08	LANmark-OF Tight Buffer Universal 8x Singlemode 9/125 OS2 LSZH Black
SM (G.652D)	N164.TBUN12	LANmark-OF Tight Buffer Universal 12x Singlemode 9/125 OS2 LSZH Black
SM (G.652D)	N164.TBUN24	LANmark-OF Tight Buffer Universal 24x Singlemode 9/125 OS2 LSZH Black

LANmark-OF Micro-Bundle Indoor

- Micro-Bundle Indoor optical fibre cable
- Indoor cable for backbones and data centres
- Small, but mechanical strong cable
- Designed for splicing with pigtails
- 12-96 fibres and available in all fibre grades

Description

Description and Application

The new Micro-Bundle technology from Nexans allows to manufacture a flexible and small tube. This Micro-Bundle is the central part of the new "LANmark-OF Micro-Bundle Indoor" cable design. The Micro-Bundle contains 12 fibres with a fibre diameter of 250 μm . Termination of these fibres is done with splicing with pigtails.

Up to 8 Micro-bundles are arranged around a central strength element. Aramid yarns provide additional strength and make the cable installer friendly. The combination of the Micro-Bundle technology, the central strength element and aramid yarns result in a mechanical robust, but also small and flexible cable. This makes it a optimised cable for data centres and backbones

The small bending radius of the LANmark-OF Micro-Bundle Indoor makes the cable easy to arrange in patch panels, in cable trays and in ducts.

The LANmark-OF Micro-Bundle Indoor complies with the indoor fire requirements. Since there is no drip effect of the very limited amount of gel the cable is optimised for both horizontal and vertical installations.

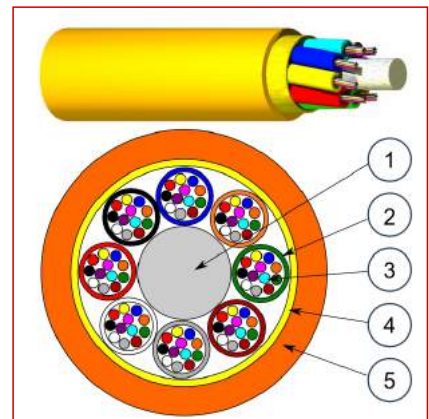

LANmark-OF

Standards

International ISO/IEC 11801

Construction

Legend accompanying the cross section drawing:

1. Central strength element
2. Micro-Bundle with 12 fibres
3. Optical fibre (250 μm)
4. Reinforced aramid yarns
5. Outer sheath in LSZH material

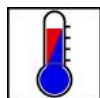
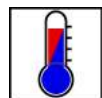
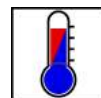
 Mechanical resistance to impacts
 10 impacts of 1 N.m

 Ambient installation temperature, range
 0 .. 40 °C

 Operating temperature, range
 -10 .. 60 °C

 Storage temperature, range
 -20 .. 60 °C

 Fire retardant
 IEC 60332-3

 Flame retardant
 IEC 60332-1

LANmark-OF Micro-Bundle Indoor

Characteristics

- Micro-Bundle design for easy installation
- Indoor cable for horizontal and vertical installations
- Data centre cable
- Flame retardant (IEC 60332-1)
- Fire retardant (IEC 60332-3)
- All dielectric design
- Designed for termination by splicing
- Aramid yarns for ease of handling and as strength element
- 12 fibres per Micro-Bundle
- Available in 12, 24, 48 and 96 fibres
- Available in all fibre grades

Characteristics







Mechanical characteristics	
Mechanical resistance to impacts	10 impacts of 1 N.m
Crush resistance (IEC 60794-1-E3)	100 N/cm
Maximum pulling force (IEC 60794-1-2-E1)	1000 N
Maximum operating pulling force	250 N
Usage characteristics	
Ambient installation temperature, range	0 .. 40 °C
Operating temperature, range	-10 .. 60 °C
Storage temperature, range	-20 .. 60 °C
Fire retardant	IEC 60332-3
Flame retardant	IEC 60332-1

Mechanical and Dimensional Characteristics for Micro-Bundle Indoor

Nb optical fibres	Nom. outer diam. [mm]	Approx. weight [kg/km]	static bending rad. [mm]	Min. dynamic operating bending rad. [mm]
12	5.4	37	65	80.0
24	5.4	37	65	80.0
48	5.4	37	65	80.0
96	6.4	50	65	100.0

N-numbers for Micro-Bundle Indoor

Fiber optic type	Nexans ref.	Name
OM1 62.5/125	N160.MBIN12	LANmark-OF Micro-Bundle Indoor 12x Multimode 62,5/125 OM1 LSZH Orange
OM1 62.5/125	N160.MBIN24	LANmark-OF Micro-Bundle Indoor 24x Multimode 62,5/125 OM1 LSZH Orange
OM1 62.5/125	N160.MBIN48	LANmark-OF Micro-Bundle Indoor 48x Multimode 62,5/125 OM1 LSZH Orange
OM1 62.5/125	N160.MBIN96	LANmark-OF Micro-Bundle Indoor 96x Multimode 62,5/125 OM1 LSZH Orange
OM2 50/125	N162.MBIN12	LANmark-OF Micro-Bundle Indoor 12x Multimode 50/125 OM2 LSZH Orange

					
Mechanical resistance to impacts 10 impacts of 1 N.m	Ambient installation temperature, range 0 .. 40 °C	Operating temperature, range -10 .. 60 °C	Storage temperature, range -20 .. 60 °C	Fire retardant IEC 60332-3	Flame retardant IEC 60332-1

LANmark-OF Micro-Bundle Indoor

Fiber optic type	Nexans ref.	Name
OM2 50/125	N162.MBIN24	LANmark-OF Micro-Bundle Indoor 24x Multimode 50/125 OM2 LSZH Orange
OM2 50/125	N162.MBIN48	LANmark-OF Micro-Bundle Indoor 48x Multimode 50/125 OM2 LSZH Orange
OM2 50/125	N162.MBIN96	LANmark-OF Micro-Bundle Indoor 96x Multimode 50/125 OM2 LSZH Orange
OM3 50/125	N165.MBIN12	LANmark-OF Micro-Bundle Indoor 12x Multimode 50/125 OM3 LSZH Orange
OM3 50/125	N165.MBIN24	LANmark-OF Micro-Bundle Indoor 24x Multimode 50/125 OM3 LSZH Orange
OM3 50/125	N165.MBIN48	LANmark-OF Micro-Bundle Indoor 48x Multimode 50/125 OM3 LSZH Orange
OM3 50/125	N165.MBIN96	LANmark-OF Micro-Bundle Indoor 96x Multimode 50/125 OM3 LSZH Orange
OM4 50/125	N167.MBIN12	LANmark-OF Micro-Bundle Indoor 12x Multimode 50/125 OM4 LSZH Orange
OM4 50/125	N167.MBIN24	LANmark-OF Micro-Bundle Indoor 24x Multimode 50/125 OM4 LSZH Orange
OM4 50/125	N167.MBIN48	LANmark-OF Micro-Bundle Indoor 48x Multimode 50/125 OM4 LSZH Orange
OM4 50/125	N167.MBIN96	LANmark-OF Micro-Bundle Indoor 96x Multimode 50/125 OM4 LSZH Orange
SM (G.652D)	N164.MBIN12	LANmark-OF Micro-Bundle Indoor 12x Singlemode 9/125 OS2 LSZH Yellow
SM (G.652D)	N164.MBIN24	LANmark-OF Micro-Bundle Indoor 24x Singlemode 9/125 OS2 LSZH Yellow
SM (G.652D)	N164.MBIN48	LANmark-OF Micro-Bundle Indoor 48x Singlemode 9/125 OS2 LSZH Yellow
SM (G.652D)	N164.MBIN96	LANmark-OF Micro-Bundle Indoor 96x Singlemode 9/125 OS2 LSZH Yellow



Mechanical resistance to impacts
10 impacts of 1 N.m



Ambient installation temperature, range
0 .. 40 °C

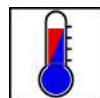

Operating temperature, range
-10 .. 60 °C

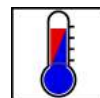

Storage temperature, range
-20 .. 60 °C



Fire retardant
IEC 60332-3



Flame retardant
IEC 60332-1

LANmark-OF Micro-Bundle Universal (24F-72F)

- Micro-Bundle Universal optical fibre cable
- Indoor cable and outdoor installation in a duct
- Fully waterproof and rodent resistant
- Small, but mechanical strong cable
- Designed for splicing with pigtails
- 24-72 fibres and available in all fibre grades

Description

Description and Application

The new Micro-Bundle technology from Nexans allows to manufacture a flexible and small tube. This Micro-Bundle is the central part of the new "LANmark-OF Micro-Bundle Universal" cable design. Each Micro-Bundle contains 12 fibres with a fibre diameter of 250 μm . Termination of these fibres is done with splicing with pigtails.

Up to 6 Micro-Bundles are arranged around a central strength element. The combination of the Micro-Bundle technology, the central strength element and the glass yarns result in a mechanical robust, but also in a small and flexible cable.

The small bending radius of the LANmark-OF Micro-Bundle Universal makes the cable easy to arrange in patch panels, in cable trays and in ducts.

The watertight glass yarns and the very limited amount of gel inside the tube make the LANmark-OF Micro-Bundle Universal design watertight, rodent resistant and suitable for installation outdoor in a duct by pulling.

The LANmark-OF Micro-Bundle Universal complies with the indoor fire requirements. Since there is no drip effect of the very limited amount of gel the cable is optimised for both horizontal and vertical installations.

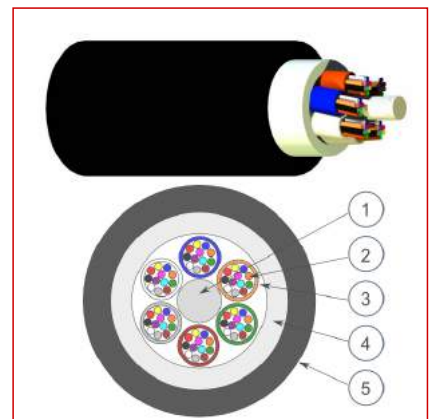

LANmark-OF









Standards

International ISO/IEC 11801

Construction

Legend accompanying the cross section drawing:

1. Central strength element
2. Optical fibre (250 μm)
3. Micro-Bundle with 12 fibres
4. Reinforced watertight glass yarns
5. Outer sheath in LSZH material with UV resistant additive

							
Mechanical resistance to impacts 10 impacts of 1 N.m	Ambient installation temperature, range 0 .. 40 °C	Operating temperature, range -30 .. 60 °C	Storage temperature, range -30 .. 60 °C	Minimum static operating bending radius 75 mm	Minimum dynamic operating bending radius 150.0 mm	Fire retardant IEC 60332-3	Flame retardant IEC 60332-1

LANmark-OF Micro-Bundle Universal (24F-72F)

Characteristics









- Micro-Bundle design for easy installation
- Indoor cable for horizontal and vertical installations
- Flame retardant (IEC 60332-1)
- Fire retardant (IEC 60332-3)
- Outdoor cable for installation in a duct
- Waterproof structure, rodent resistant and UV-resistant
- All dielectric design
- Designed for termination by splicing
- 12 fibres per Micro-Bundle
- Available in 24, 48 and 96 fibres
- Available in all fibre grades

Characteristics

Dimensional characteristics	
Approximate weight	64 kg/km
Nominal outer diameter	7.2 mm
Mechanical characteristics	
Mechanical resistance to impacts	10 impacts of 1 N.m
Crush resistance (IEC 60794-1-E3)	100 N/cm
Maximum operating pulling force	600 N
Maximum pulling force (IEC 60794-1-2-E1)	2000 N
Usage characteristics	
Ambient installation temperature, range	0 .. 40 °C
Operating temperature, range	-30 .. 60 °C
Storage temperature, range	-30 .. 60 °C
Minimum static operating bending radius	75 mm
Minimum dynamic operating bending radius	150.0 mm
Fire retardant	IEC 60332-3
Flame retardant	IEC 60332-1

N-number for Micro-Bundle Universal (24F-72F)

Fiber optic type	Nexans ref.	Name
OM1 62.5/125	N160.MBUN24	LANmark-OF Micro-Bundle Universal 24x Multimode 62,5/125 OM1 LSZH Black
OM1 62.5/125	N160.MBUN48	LANmark-OF Micro-Bundle Universal 48x Multimode 62,5/125 OM1 LSZH Black
OM1 62.5/125	N160.MBUN72	LANmark-OF Micro-Bundle Universal 72x Multimode 62,5/125 OM1 LSZH Black
OM2 50/125	N162.MBUN24	LANmark-OF Micro-Bundle Universal 24x Multimode 50/125 OM2 LSZH Black
OM2 50/125	N162.MBUN48	LANmark-OF Micro-Bundle Universal 48x Multimode 50/125 OM2 LSZH Black
OM2 50/125	N162.MBUN72	LANmark-OF Micro-Bundle Universal 72x Multimode 50/125 OM2 LSZH Black
OM3 50/125	N165.MBUN24	LANmark-OF Micro-Bundle Universal 24x Multimode 50/125 OM3 LSZH Black

							
Mechanical resistance to impacts 10 impacts of 1 N.m	Ambient installation temperature, range 0 .. 40 °C	Operating temperature, range -30 .. 60 °C	Storage temperature, range -30 .. 60 °C	Minimum static operating bending radius 75 mm	Minimum dynamic operating bending radius 150.0 mm	Fire retardant IEC 60332-3	Flame retardant IEC 60332-1
03/12/10 - http://www.nexans.co.uk						Page 155 / 285	
All drawings, designs, specifications, plans and particulars of weights, size and dimensions contained in the technical or commercial documentation of Nexans is indicative only and shall not be binding on Nexans or be treated as constituting a representation on the part of Nexans.							

LANmark-OF Micro-Bundle Universal (24F-72F)

Fiber optic type	Nexans ref.	Name
OM3 50/125	N165.MBUN48	LANmark-OF Micro-Bundle Universal 48x Multimode 50/125 OM3 LSZH Black
OM3 50/125	N165.MBUN72	LANmark-OF Micro-Bundle Universal 72x Multimode 50/125 OM3 LSZH Black
OM4 50/125	N167.MBUN24	LANmark-OF Micro-Bundle Universal 24x Multimode 50/125 OM4 LSZH Black
OM4 50/125	N167.MBUN48	LANmark-OF Micro-Bundle Universal 48x Multimode 50/125 OM4 LSZH Black
OM4 50/125	N167.MBUN72	LANmark-OF Micro-Bundle Universal 72x Multimode 50/125 OM4 LSZH Black
SM (G.652D)	N164.MBUN24	LANmark-OF Micro-Bundle Universal 24x Singlemode 9/125 OS2 LSZH Black
SM (G.652D)	N164.MBUN48	LANmark-OF Micro-Bundle Universal 48x Singlemode 9/125 OS2 LSZH Black
SM (G.652D)	N164.MBUN72	LANmark-OF Micro-Bundle Universal 72x Singlemode 9/125 OS2 LSZH Black



Mechanical resistance to impacts
10 impacts of 1 N.m



Ambient installation temperature, range
0 .. 40 °C



Operating temperature, range
-30 .. 60 °C



Storage temperature, range
-30 .. 60 °C



Minimum static operating bending radius
75 mm



Minimum dynamic operating bending radius
150.0 mm



Fire retardant IEC
60332-3



Flame retardant IEC
60332-1

LANmark-OF Micro-Bundle Universal (4F-12F)

- Micro-Bundle Universal optical fibre cable
- Indoor cable and outdoor installation in a duct
- Fully waterproof and rodent retardant
- Designed for splicing with pigtails
- 4-12 fibres and available in all fibre grades

Description

Description and Application

The new Micro-Bundle technology from Nexans allows to manufacture a very flexible and small tube that is the central part of the new "LANmark-OF Micro-Bundle Universal" cable design. This results in a small, flexible, but mechanical robust cable. The central tube contains up till 12 fibres with a fibre diameter of 250 um. Termination of these fibres is done with splicing with pigtails.

The small bending radius of the Micro-Bundle makes the cable easy to arrange in patch panels and for installations in data centres and backbones.

The watertight glass yarns and the very limited amount of gel inside the tube makes this cable design watertight and suitable for installation outdoor in a duct by pulling.

The fire performance of the LANmark-OF Micro-Bundle Universal allows indoor installation as well. Since there is no drip effect of the very limited amount of gel the cable is optimised for both horizontal and vertical installations.

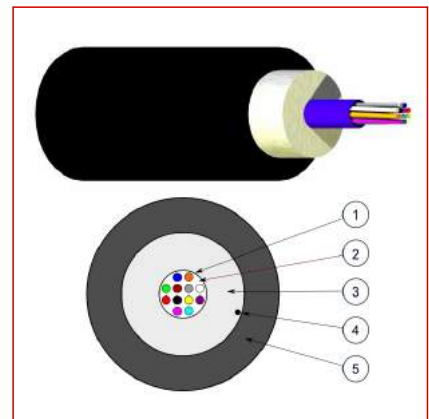

LANmark-OF

Standards

International ISO/IEC 11801

Construction

1. Central Micro-Bundle
2. Gel
3. Reinforced watertight glass yarns
4. Ripcord
5. LSZH outer jacket with UV resistant additive

Characteristics

- Indoor cable for horizontal and vertical installation
- Outdoor cable for installation in a duct
- Designed for termination by splicing
- Central Micro-Bundle design for easy installation
- All dielectric
- Waterproof structure, Rodent retardant and UV-resistant
- Flame retardant (IEC 60332-1) and fire retardant (IEC 60331-3)
- Available in all fibre grades and from 4-12 fibres



Mechanical resistance to impacts
1 impact of 3 N.m



Flame retardant
IEC 60332-1



Fire retardant
IEC 60332-3

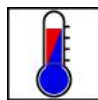

Ambient installation temperature, range
0 .. 40 °C

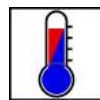

Operating temperature, range
-20 .. 60 °C

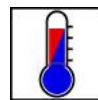

Storage temperature, range
-40 .. 60 °C



Minimum static operating bending radius
60 mm



Minimum dynamic operating bending radius
60.0 mm

LANmark-OF Micro-Bundle Universal (4F-12F)

Characteristics

Dimensional characteristics	
Approximate weight	42 kg/km
Nominal outer diameter	5.6 mm
Mechanical characteristics	
Mechanical resistance to impacts	1 impact of 3 N.m
Crush resistance (IEC 60794-1-E3)	200 N/cm
Maximum operating pulling force	700 N
Maximum pulling force (IEC 60794-1-2-E1)	2200 N
Usage characteristics	
Flame retardant	IEC 60332-1
Fire retardant	IEC 60332-3
Ambient installation temperature, range	0 .. 40 °C
Operating temperature, range	-20 .. 60 °C
Storage temperature, range	-40 .. 60 °C
Minimum static operating bending radius	60 mm
Minimum dynamic operating bending radius	60.0 mm

N-numbers for Micro-Bundle Universal

Fiber optic type	Nexans ref.	Name
OM1 62.5/125	N160.MBUN04	LANmark-OF Micro-Bundle Universal 4x Multimode 62,5/125 OM1 LSZH Black
OM1 62.5/125	N160.MBUN06	LANmark-OF Micro-Bundle Universal 6x Multimode 62,5/125 OM1 LSZH Black
OM1 62.5/125	N160.MBUN08	LANmark-OF Micro-Bundle Universal 8x Multimode 62,5/125 OM1 LSZH Black
OM1 62.5/125	N160.MBUN12	LANmark-OF Micro-Bundle Universal 12x Multimode 62,5/125 OM1 LSZH Black
OM2 50/125	N162.MBUN04	LANmark-OF Micro-Bundle Universal 4x Multimode 50/125 OM2 LSZH Black
OM2 50/125	N162.MBUN06	LANmark-OF Micro-Bundle Universal 6x Multimode 50/125 OM2 LSZH Black
OM2 50/125	N162.MBUN08	LANmark-OF Micro-Bundle Universal 8x Multimode 50/125 OM2 LSZH Black
OM2 50/125	N162.MBUN12	LANmark-OF Micro-Bundle Universal 12x Multimode 50/125 OM2 LSZH Black
OM3 50/125	N165.MBUN04	LANmark-OF Micro-Bundle Universal 4x Multimode 50/125 OM3 LSZH Black
OM3 50/125	N165.MBUN06	LANmark-OF Micro-Bundle Universal 6x Multimode 50/125 OM3 LSZH Black
OM3 50/125	N165.MBUN08	LANmark-OF Micro-Bundle Universal 8x Multimode 50/125 OM3 LSZH Black
OM3 50/125	N165.MBUN12	LANmark-OF Micro-Bundle Universal 12x Multimode 50/125 OM3 LSZH Black
OM4 50/125	N167.MBUN04	LANmark-OF Micro-Bundle Universal 4x Multimode 50/125 OM4 LSZH Black
OM4 50/125	N167.MBUN06	LANmark-OF Micro-Bundle Universal 6x Multimode 50/125 OM4 LSZH Black
OM4 50/125	N167.MBUN08	LANmark-OF Micro-Bundle Universal 8x Multimode 50/125 OM4 LSZH Black
OM4 50/125	N167.MBUN12	LANmark-OF Micro-Bundle Universal 12x Multimode 50/125 OM4 LSZH Black
SM (G.652D)	N164.MBUN04	LANmark-OF Micro-Bundle Universal 4x Singlemode 9/125 OS2 LSZH Black
SM (G.652D)	N164.MBUN06	LANmark-OF Micro-Bundle Universal 6x Singlemode 9/125 OS2 LSZH Black
SM (G.652D)	N164.MBUN08	LANmark-OF Micro-Bundle Universal 8x Singlemode 9/125 OS2 LSZH Black
SM (G.652D)	N164.MBUN12	LANmark-OF Micro-Bundle Universal 12x Singlemode 9/125 OS2 LSZH Black

LANmark-OF UD PE

- UD optical fibre cables
- Suitable for outdoor in ducts or direct burial
- Full dielectric armour
- Available in all fibre grades and till 24 fibres
- Rodent resistance

Description

Description and Application

The LANmark-OF UD PE cable is designed as a campus cable. It can be pulled in a duct outside or can be direct buried. Its full dielectric armouring does not provide an electrical path and hence the cable can be used to connect 2 buildings.

The central loose tube is surrounded by robust strength elements: Fibre Reinforced Plastic (FRP) elements. These FRP provide the cable with a high rodent resistant and a high resistant against impacts and compression. There are 4 x FRP and 5 x fillers for fibre counts 4-12. For 14-24 fibres there are 5 X FRP and 5 X fillers.

The loose tube design has a capacity of up to 24 fibres. Diameter of the fibres is 250 um. Termination of these fibres is done with splicing of pigtails.

The cable is watertight due to the gel in the loose tube and the watertight glass yarns.

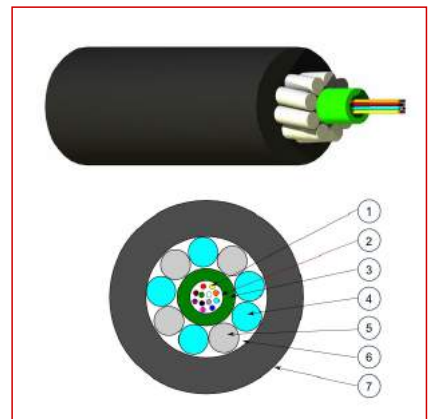

LANmark-OF

Standards



International ISO/IEC 11801

Construction

Legend accompanying the cross section drawing:

1. Optical fibres (250 um)
2. Gel
3. Loose tube
4. Fillers
5. Fibre Reinforced Plastic strength elements
6. Reinforced watertight glass yarns
7. PE outer jacket with UV resistant additive

Characteristics

 Ambient installation temperature, range 0 .. 40 °C	 Operating temperature, range -30 .. 60 °C	 Storage temperature, range -40 .. 70 °C
--	---	---

LANmark-OF UD PE

- Outdoor cable for installation in a duct or direct burial
- Designed for termination by splicing
- Central loose tube design
- All dielectric design with FRP reinforcement and glass yarns
- Waterproof structure, rodent resistant and UV-resistant
- Available in all fibre grades
- Available from 4-24 fibres
- Excellent friction properties

Characteristics

Usage characteristics

Ambient installation temperature, range	0 .. 40 °C
Operating temperature, range	-30 .. 60 °C
Storage temperature, range	-40 .. 70 °C

Mechanical and Dimensional Characteristics for LANmark-OF UD PE

Nb optical fibres	Nom. outer diam. [mm]	Approx. weight [kg/km]	Min. dynamic operating bending rad. [mm]	static bending rad. [mm]	Crush resistance (IEC 60794-1-E3) [N/cm]	Mechanical resistance to impacts	Maximum pulling force (IEC 60794-1-2-E1) [N]	Maximum operating pulling force [N]
4	8.1	50	205.0	160	300	100 impacts of 3 N.m	1150	560
6	8.1	50	205.0	160	300	100 impacts of 3 N.m	1150	560
8	8.1	50	205.0	160	300	100 impacts of 3 N.m	1150	560
12	8.1	50	205.0	160	300	100 impacts of 3 N.m	1150	560
24	9,1	73	225,0	180	400	100 impacts of 5 N.m	1450	700

N-numbers for LANmark-OF UD PE

Nexans ref.	Name
N160.681	LANmark-OF UD 4x Multimode 62,5/125 OM1 PE Black
N160.682	LANmark-OF UD 6x Multimode 62,5/125 OM1 PE Black
N160.683	LANmark-OF UD 8x Multimode 62,5/125 OM1 PE Black
N160.685	LANmark-OF UD 12x Multimode 62,5/125 OM1 PE Black
N160.691	LANmark-OF UD 24x Multimode 62,5/125 OM1 PE Black
N162.681	LANmark-OF UD 4x Multimode 50/125 OM2 PE Black
N162.682	LANmark-OF UD 6x Multimode 50/125 OM2 PE Black
N162.683	LANmark-OF UD 8x Multimode 50/125 OM2 PE Black

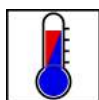

Ambient installation temperature, range
0 .. 40 °C

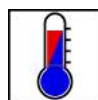

Operating temperature, range
-30 .. 60 °C

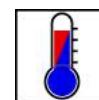

Storage temperature, range
-40 .. 70 °C

LANmark-OF UD PE

Nexans ref.	Name
N162.685	LANmark-OF UD 12x Multimode 50/125 OM2 PE Black
N162.691	LANmark-OF UD 24x Multimode 50/125 OM2 PE Black
N164.681	LANmark-OF UD 4x Singlemode 9/125 OS2 PE Black
N164.682	LANmark-OF UD 6x Singlemode 9/125 OS2 PE Black
N164.683	LANmark-OF UD 8x Singlemode 9/125 OS2 PE Black
N164.685	LANmark-OF UD 12x Singlemode 9/125 OS2 PE Black
N164.691	LANmark-OF UD 24x Singlemode 9/125 OS2 PE Black
N165.681	LANmark-OF UD 4x Multimode 50/125 OM3 PE Black
N165.682	LANmark-OF UD 6x Multimode 50/125 OM3 PE Black
N165.683	LANmark-OF UD 8x Multimode 50/125 OM3 PE Black
N165.685	LANmark-OF UD 12x Multimode 50/125 OM3 PE Black
N165.691	LANmark-OF UD 24x Multimode 50/125 OM3 PE Black
N167.681	LANmark-OF UD 4x Multimode 50/125 OM4 PE Black
N167.682	LANmark-OF UD 6x Multimode 50/125 OM4 PE Black
N167.683	LANmark-OF UD 8x Multimode 50/125 OM4 PE Black
N167.685	LANmark-OF UD 12x Multimode 50/125 OM4 PE Black
N167.691	LANmark-OF UD 24x Multimode 50/125 OM4 PE Black

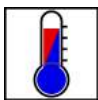

Ambient installation temperature, range
0 .. 40 °C

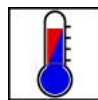

Operating temperature, range
-30 .. 60 °C

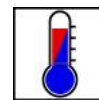

Storage temperature, range
-40 .. 70 °C

LANmark-OF UC PE

UC optical fibre cables

- Outdoor in ducts or direct burial
- Corrugated steel tape armour
- Available in all fibres grades
- Provides full rodent protection

Description

Description and Application

The construction is suitable for use outdoor in ducts and for direct burial. It consists of a corrugated steel tape armouring providing full rodent protection. It is surrounded by glass yarns. The cable has a HDPE outer jacket. The loose tube design has a capacity of up to 24 fibres. Diameter of the fibres is 250 µm. Termination of these fibres is done with splicing of pigtails. The cable is watertight due to the gel in the loose tube and the watertight glass yarns.

Construction

Legend accompanying the cross section drawing:

1. Optical fibres (250 µm)
2. Gel
3. Loose tube
4. Reinforced watertight glass yarns
5. Corrugated steel tape armour
6. PE outer jacket with UV resistant additive

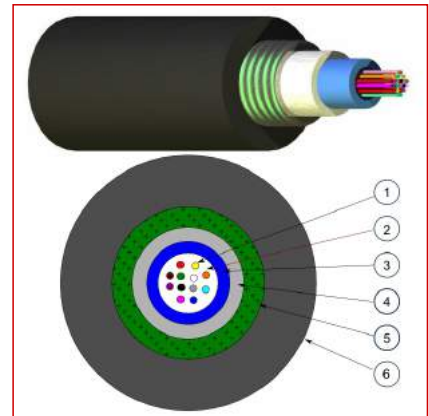

LANmark-OF

Standards

International ISO/IEC 11801

Characteristics

- Outdoor cable for installation in a duct or direct burial
- Designed for termination by splicing
- Central loose tube design
- Corrugated steel protection
- Waterproof structure, rodent resistant and UV-resistant
- Available in all fibre grades
- Available from 4-24 fibres



Mechanical resistance to impacts
 100 impacts of 3 Nm



Minimum dynamic operating bending radius
 200.0 mm



Minimum static operating bending radius
 140 mm



Operating temperature, range
 -20 .. 60 °C



Storage temperature, range
 -30 .. 60 °C

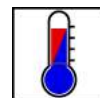

Ambient installation temperature, range
 0 .. 40 °C

LANmark-OF UC PE

Characteristics

Dimensional characteristics	
Nominal outer diameter	9.5 mm
Approximate weight	100 kg/km
Mechanical characteristics	
Mechanical resistance to impacts	100 impacts of 3 N.m
Maximum pulling force (IEC 60794-1-2-E1)	1500 N
Maximum operating pulling force	450 N
Crush resistance (IEC 60794-1-E3)	300 N/cm
Usage characteristics	
Minimum dynamic operating bending radius	200.0 mm
Minimum static operating bending radius	140 mm
Operating temperature, range	-20 .. 60 °C
Storage temperature, range	-30 .. 60 °C
Ambient installation temperature, range	0 .. 40 °C

N-numbers for LANmark-OF UC PE

Fiber optic type	Nexans ref.	Name
OM1 62.5/125	N160.181	LANmark-OF UC 4x Multimode 62,5/125 OM1 PE Black
OM1 62.5/125	N160.182	LANmark-OF UC 6x Multimode 62,5/125 OM1 PE Black
OM1 62.5/125	N160.183	LANmark-OF UC 8x Multimode 62,5/125 OM1 PE Black
OM1 62.5/125	N160.185	LANmark-OF UC 12x Multimode 62,5/125 OM1 PE Black
OM1 62.5/125	N160.191	LANmark-OF UC 24x Multimode 62,5/125 OM1 PE Black
OM2 50/125	N162.181	LANmark-OF UC 4x Multimode 50/125 OM2 PE Black
OM2 50/125	N162.182	LANmark-OF UC 6x Multimode 50/125 OM2 PE Black
OM2 50/125	N162.183	LANmark-OF UC 8x Multimode 50/125 OM2 PE Black
OM2 50/125	N162.185	LANmark-OF UC 12x Multimode 50/125 OM2 PE Black
OM2 50/125	N162.191	LANmark-OF UC 24x Multimode 50/125 OM2 PE Black
OM3 50/125	N165.181	LANmark-OF UC 4x Multimode 50/125 OM3 PE Black
OM3 50/125	N165.182	LANmark-OF UC 6x Multimode 50/125 OM3 PE Black
OM3 50/125	N165.183	LANmark-OF UC 8x Multimode 50/125 OM3 PE Black
OM3 50/125	N165.185	LANmark-OF UC 12x Multimode 50/125 OM3 PE Black
OM3 50/125	N165.191	LANmark-OF UC 24x Multimode 50/125 OM3 PE Black
OM4 50/125	N167.181	LANmark-OF UC 4x Multimode 50/125 OM4 PE Black
OM4 50/125	N167.182	LANmark-OF UC 6x Multimode 50/125 OM4 PE Black
OM4 50/125	N167.183	LANmark-OF UC 8x Multimode 50/125 OM4 PE Black
OM4 50/125	N167.185	LANmark-OF UC 12x Multimode 50/125 OM4 PE Black
OM4 50/125	N167.191	LANmark-OF UC 24x Multimode 50/125 OM4 PE Black
SM (G.652D)	N164.181	LANmark-OF UC 4x Singlemode 9/125 OS2 PE Black
SM (G.652D)	N164.182	LANmark-OF UC 6x Singlemode 9/125 OS2 PE Black
SM (G.652D)	N164.183	LANmark-OF UC 8x Singlemode 9/125 OS2 PE Black
SM (G.652D)	N164.185	LANmark-OF UC 12x Singlemode 9/125 OS2 PE Black
SM (G.652D)	N164.191	LANmark-OF UC 24x Singlemode 9/125 OS2 PE Black

LANmark-OF UC LSZH

UC optical fibre cables

- Indoor/Outdoor cable
- Corrugated steel tape armour
- Gel filled tube
- All fibre grades
- Provides full rodent protection
- Low Smoke Zero Halogene (LSZH)

Description

Description and Application

The construction is suitable for indoor/outdoor use. It consists of a corrugated steel tape armouring providing full rodent protection. It is surrounded by glass yarns. The cable has a LSZH outer jacket.

The loose tube design has a capacity of up to 24 fibres. Diameter of the fibres is 250 μm . Termination of these fibres is done with splicing of pigtailed.

The cable is watertight due to the gel in the loose tube and the watertight glass yarns.

Construction

Legend accompanying the cross section drawing:

1. Optical fibres (250 μm)
2. Gel
3. Loose tube
4. Reinforced watertight glass yarns
5. Corrugated steel tape armour
6. LSZH outer jacket with UV resistant additive

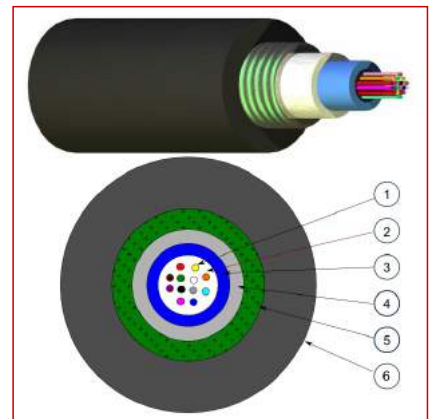

LANmark-OF

Standards

International ISO/IEC 11801

Characteristics

- Indoor/Outdoor cable
- Flame and fire non propagation
- Designed for termination by splicing
- Central loose tube design
- Corrugated steel protection
- Waterproof structure, rodent resistant and UV-resistant
- Available in all fibre grades
- Available from 4-24 fibres



Mechanical resistance to impacts
100 impacts of 3 N.m



Minimum dynamic operating bending radius
210.0 mm



Minimum static operating bending radius
150 mm



Ambient installation temperature, range
0 .. 40 °C



Operating temperature, range
-20 .. 60 °C

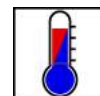

Storage temperature, range
-30 .. 60 °C



Fire retardant IEC
60332-3



Flame retardant IEC
60332-1

LANmark-OF UC LSZH

Characteristics

Dimensional characteristics	
Approximate weight	129 kg/km
Nominal outer diameter	9.5 mm
Mechanical characteristics	
Maximum pulling force (IEC 60794-1-2-E1)	1500 N
Maximum operating pulling force	450 N
Mechanical resistance to impacts	100 impacts of 3 N.m
Crush resistance (IEC 60794-1-E3)	300 N/cm
Usage characteristics	
Minimum dynamic operating bending radius	210.0 mm
Minimum static operating bending radius	150 mm
Ambient installation temperature, range	0 .. 40 °C
Operating temperature, range	-20 .. 60 °C
Storage temperature, range	-30 .. 60 °C
Fire retardant	IEC 60332-3
Flame retardant	IEC 60332-1

N-numbers for LANmark-OF UC LSZH

Fiber optic type	Nexans ref.	Name
OM1 62.5/125	N160.471	LANmark-OF UC 4x Multimode 62,5/125 OM1 LSZH Black
OM1 62.5/125	N160.472	LANmark-OF UC 6x Multimode 62,5/125 OM1 LSZH Black
OM1 62.5/125	N160.473	LANmark-OF UC 8x Multimode 62,5/125 OM1 LSZH Black
OM1 62.5/125	N160.475	LANmark-OF UC 12x Multimode 62,5/125 OM1 LSZH Black
OM1 62.5/125	N160.481	LANmark-OF UC 24x Multimode 62,5/125 OM1 LSZH Black
OM2 50/125	N162.471	LANmark-OF UC 4x Multimode 50/125 OM2 LSZH Black
OM2 50/125	N162.472	LANmark-OF UC 6x Multimode 50/125 OM2 LSZH Black
OM2 50/125	N162.473	LANmark-OF UC 8x Multimode 50/125 OM2 LSZH Black
OM2 50/125	N162.475	LANmark-OF UC 12x Multimode 50/125 OM2 LSZH Black
OM2 50/125	N162.481	LANmark-OF UC 24x Multimode 50/125 OM2 LSZH Black
OM3 50/125	N165.471	LANmark-OF UC 4x Multimode 50/125 OM3 LSZH Black
OM3 50/125	N165.472	LANmark-OF UC 6x Multimode 50/125 OM3 LSZH Black
OM3 50/125	N165.473	LANmark-OF UC 8x Multimode 50/125 OM3 LSZH Black
OM3 50/125	N165.475	LANmark-OF UC 12x Multimode 50/125 OM3 LSZH Black
OM3 50/125	N165.481	LANmark-OF UC 24x Multimode 50/125 OM3 LSZH Black
OM4 50/125	N167.471	LANmark-OF UC 4x Multimode 50/125 OM4 LSZH Black
OM4 50/125	N167.472	LANmark-OF UC 6x Multimode 50/125 OM4 LSZH Black
OM4 50/125	N167.473	LANmark-OF UC 8x Multimode 50/125 OM4 LSZH Black
OM4 50/125	N167.475	LANmark-OF UC 12x Multimode 50/125 OM4 LSZH Black
OM4 50/125	N167.481	LANmark-OF UC 24x Multimode 50/125 OM4 LSZH Black
SM (G.652D)	N164.471	LANmark-OF UC 4x Singlemode 9/125 OS2 LSZH Black
SM (G.652D)	N164.472	LANmark-OF UC 6x Singlemode 9/125 OS2 LSZH Black
SM (G.652D)	N164.473	LANmark-OF UC 8x Singlemode 9/125 OS2 LSZH Black
SM (G.652D)	N164.475	LANmark-OF UC 12x Singlemode 9/125 OS2 LSZH Black
SM (G.652D)	N164.481	LANmark-OF UC 24x Singlemode 9/125 OS2 LSZH Black

Cables - LANmark-OF ZC LSZH

ZipCord optical fibre cables

- Designed for direct termination on ST, SC or LC connectors
- Suitable for indoor use in horizontal cabling and risers
- Suitable for use in patch assembly
- Available in all fibre grades

Description

Application

LANmark-OF ZC optical fibre cables have been designed for applications where a high level of installation, environmental and optical performance is required. The ZipCord range is most suitable for direct termination in patch assembly and in risers and horizontal cabling.

The majority of the tight buffered cables are suitable for both internal & external environments and are all dielectric with excellent flame retardance

Applications support :

- FDDI 100 Mbps
- Ethernet 10 base FL
- Fast Ethernet 100 base FX
- Gbit Ethernet 1000 base SX/LX
- 10Gbit Ethernet 10000 base SX(*)
- Fibre Channel 1.0625 Gbps
- ATM 155 Mbps
- ATM 622 Mbps

(*) in accordance with IEEE 802.3ae

Performance

LANmark-OF Tight Buffered optical fibre cables are available with standard multimode & singlemode fibres whilst the LANmark-OFxt ranges are supplied with Laser Optimised multimode fibres offering extended application distances for Gigabit Ethernet.

Construction

Legend accompanying the cross section drawing:

1. 900 µm tight buffered fibre
2. Aramid yarns reinforcement
3. Flame retardant halogen free outer sheath



LANmark-OF

Standards

International ISO/IEC 11801



Flame retardant
IEC 60332 Part 3 Cat. C

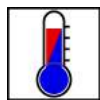

Ambient installation temperature,
range
0 .. 40 °C

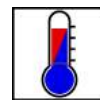

Operating temperature, range
-10 .. 70 °C

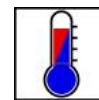

Storage temperature, range
-30 .. 70 °C

Cables - LANmark-OF ZC LSZH

Characteristics

Construction characteristics	
Type of cable	Zip Cord (ZC)
Armour type	Unarmoured
Material of filler / inner sheath	Aramid yarn
Outer sheath	LSZH-FR
Dimensional characteristics	
Number of optical fibres	2
Height	2.8 mm
Width	5.8 mm
Approximate weight	14 kg/km
Mechanical characteristics	
Crush resistance (IEC 60794-1-E3)	300 N/cm
Usage characteristics	
Installation type	Indoor
Flame retardant	IEC 60332 Part 3 Cat. C
Ambient installation temperature, range	0 .. 40 °C
Operating temperature, range	-10 .. 70 °C
Storage temperature, range	-30 .. 70 °C

Product List

☎ = Make to order, 📦 = Make to stock

Nexans ref.	Name	Fiber optic type
📦 N162.001	LANmark-OF ZC (2,8mm) 2x Multimode 50/125 OM2 LSZH Orange	OM2 50/125
📦 N163.001	LANmark-OF ZC (2,8mm) 2x Multimode 50/125 OM2xt LSZH Orange	OM2 50/125 Extended Distance
📦 N165.001	LANmark-OF ZC (2,8mm) 2x Multimode 50/125 OM3 LSZH Orange	OM3 50/125
📦 N166.001	LANmark-OF ZC (2,8mm) 2x Multimode 50/125 OM3xt LSZH Orange	OM3 50/125 Extended Distance
📦 N160.001	LANmark-OF ZC (2,8mm) 2x Multimode 62,5/125 OM1 LSZH Orange	OM1 62.5/125
📦 N161.001	LANmark-OF ZC (2,8mm) 2x Multimode 62,5/125 OM1xt LSZH Orange	OM1 62.5/125 Extended Distance
📦 N164.001	LANmark-OF ZC (2,8mm) 2x Singlemode 9/125 OS2 LSZH Yellow	SM (G.652D)

☎ = Make to order, 📦 = Make to stock

Fibre Connectors & Connector Accessories

LANmark-OF offers cutting edge connectivity products including connectors, couplers, pigtails, patch cords,...

Each product has been thoroughly developed to ensure best system offering while meeting stringent international standards.

Small Form Factor products

Full range of pigtails, patchcords and adaptors supporting both small form factor MT-RJ and LC connectors as well as ST and SC connectors.

Snap-in concept

Nexans 'snap-in' format allows quick and easy installation without screws. They are available in SC format as well as the small form factor LC and MT-RJ connectors.



LANmark-OF Connectors

- Connector for on-site termination
- Installed using the Nexans anaerobic toolkit
- Suitable for installation on 900µm fibre as well as on cable

Description

Nexans offers a large range of Fibre Optics connectors for field termination practices. All these connectors meet most recent standard ISO 11801 releases.

Connector type available :

- SC
- ST
- LC

For optimal installations, Nexans recommends to use its Anaerobic Toolkit (ref.: 102.220). This toolkit provides a comprehensive set of tools and consumables for easier on-site jobs and is supplied with illustrated installation manual.



LANmark-OF

Standards

International ISO/IEC 11801

Product List

☎ = Make to order, 📦 = Make to stock

Nexans ref.	Name	Fiber optic type	Connector type
☎ N102.461	LANmark-OF ST Connector Anaerobic Multimode for 900µm /2.8mm	Multimode	ST
☎ N102.462	LANmark-OF Simplex SC Connector Multimode for 900µm / 2.8mm (3M Hot Melt)	Multimode	SC
☎ N205.120	LANmark-OF Simplex SC Connector Anaerobic Multimode for 900µm /2.8mm	Multimode	SC
☎ N205.121	LANmark-OF Simplex ST Connector Multimode for 900µm / 2.8mm (3M Hot Melt)	Multimode	ST
☎ N890.008	LANmark-OF Simplex SC Connector Singlemode for 900µm / 2.8mm (3M Hot Melt)	SingleMode 9/125	SC
☎ N205.630	LANmark-OF Simplex LC Connector Anaerobic Multimode for 900µm	Multimode	LC
☎ N205.631	LANmark-OF Simplex LC Connector Anaerobic Multimode for 1.6-2.2mm	Multimode	LC

☎ = Make to order, 📦 = Make to stock

Contact

LAN Systems (Nexans Cabling Solutions)
Phone: +44 (0)1256 486640
ncs.uk@nexans.com

Connector Accessories

Description

Tools & accessories for termination of Nexans connectors



LANmark-OF

Standards

International ISO/IEC 11801

Connector Accessories

Product List

☎ = Make to order, 📦 = Make to stock

Nexans ref.	Name
📦 N102.221	Adhesive & Activator for Anaerobic Connector
📦 N102.214	LANmark-OF Toolkit for Anaerobic Connector (extension to hotmelt kit)
📦 N102.220	LANmark-OF Toolkit for Anaerobic Connector (starter kit)
📦 N102.222	Polishing Paper 1 micron for Anaerobic Toolkit (50/bag)
📦 N102.224	Polishing Paper 12 micron for Anaerobic Toolkit (10/bag)
📦 N102.223	Polishing Paper 3 micron for Anaerobic Toolkit (50/bag)
📦 N102.225	Syringes for Anaerobic Toolkit (50/box)
📦 N102.226	Wipes for Anaerobic Toolkit (100/box)

☎ = Make to order, 📦 = Make to stock

Pre-Terminated Fibre Assemblies

This added-value offer enables fast network deployment and removes the requirement for specialized termination training, consumables and toolkits. Every assembly is developed and manufactured by optical engineers to individual customer requirements: cable length, connector type, fibre grade, fanouts size, ...

All LANmark-OF Pre-Term assemblies are fully terminated and tested in a quality assured factory environment. They are delivered with test results and benefit from the 25 year LANmark-OF warranty program.

LANmark-OF Pre-Term significantly reduces installation time and cost while guaranteeing full scalability and long lasting reliability for every situation whether campus, backbone, Local/Storage Area Network or Data Centre.



LANmark-OF OM3, OM4, Singlemode (OS2) Fibre Assembly

Factory Pre-terminated assemblies which combine ease of installation and outstanding performances. 100% customised for your needs, this product meet the most demanding lead-times.

Description

The solution consist of universal **indoor cable** assembled in factory with connectors at each end. **Any type of connectors** can be used for the assembly: ST, SC, LC, MTRJ, etc. Fibre types available: Single mode 9/125µm (OS2 cables with G652D fibres) and laser optimised 50/125µm OM3 or OM4 fibres. A **pulling eye system** is positioned at the end of the cable to protect the terminations while pulling the cable. When the cable has been installed, the pulling eye system is cut off and the terminated fibres are fed into a patch panel. Since the assembly is done in factory, all pre-terminated fibre optic cables are **100% tested** and supplied with test results.



Applications

Interbuilding and Intrabuilding backbones for Local Area Network (**LAN**) Premise and Campus applications. Horizontal fibre distribution to work area and zone. Equipment distribution area trunk cables for **Data centre** and Storage Area Network (**SAN**) applications.

Applications support :

- Ethernet 10 base FL
- Fast Ethernet 100 base FX
- Gigabit Ethernet 1000 base SX/LX
- 10 Gigabit Ethernet 10G Base SX/LX
- 1-2-4-10 Gbps Fibre Channel

Fibre types

The Pre-Terms are available with singlemode (9/125 µm) fibre with G652D fibres. This results in OS2 cables.

For multimode laser optimised fibres (50/125 µm) are available with OM3 or OM4 performance.

Details with the exact optical performance can be found in the specific fibre datasheets.

Benefits

- Short & reliable manufacturing lead-time
- Fast installation times
- No specialised termination training required
- No consumables, termination tool kits
- No cable preparation necessary
- No cable or connector scrap
- No termination errors on site
- Delivered fully tested, labelled and documented
- High performing connectors: Max IL 0,40dB*
- Improved end-to-end attenuation
- Improved application migration
- Reduced on-site disruption and installation time
- Highly cost effective solution

*For LC-SC-ST

LANmark-OF

Standards

International ISO/IEC 11801

LANmark-OF OM3, OM4, Singlemode (OS2) Fibre Assembly

Tailor made solution

Nexans **LANmark-OF** pre-term solutions are **100% tailor made** solutions. You specify your cable and connectivity requirements and our optical engineers develop and manufacture your end-to-end pre-terminated cable solution.

What needs to be specified:

1. Cable type Singlemode OS2-OM3-OM4
2. Fibre count: 6-12-24
3. cable length between enclosures
4. Fanout size (900 μ or 2.0 mm)
5. Connector type on each end LC-MTRJ- SC-ST
6. Use of pulling system

Consistent quality

In order to produce high quality, reliable pre-terminated multi-fibre cables, there are a number of physical characteristics that must be addressed. Therefore, all LANmark-OF Pre-term assemblies are fully terminated and tested in a quality assured factory environment. They are delivered with test results protocol and benefit from the 25 years LANmark-OF warranty program.

LANmark-OF OM3, OM4, Singlemode (OS2) Fibre Assembly

LANmark-OF Pre-Term specifications

Cable Specifications

Fibre count	Diameter	Sheath	Min. bending radius
6	6,10mm	LSZH	150 mm
12	6,60mm	LSZH	150 mm
24	8,1mm	LSZH	150 mm

Fibre count	Max Pulling force	Compression	Impacts	Temp.range
6	100daN	100daN/dm	100 impacts of 1 N.m	-20°C +60°C
12	140daN	100daN/dm	100 impacts of 1 N.m	-20°C +60°C
24	140daN	100daN/dm	100 impacts of 1 N.m	-20°C +60°C

Measurement Standard Mechanical Performances

Min.bending radius	IEC-60794-1-E10
Maximum pulling force	IEC-60794-1-E1
Compression	IEC-60794-1-E3
Impacts	IEC-60794-1-E4
Operating temperatures	IEC-60794-1-F1

Connector specifications

Type	Standard Max IL	LANmark-OF Pre-term	Stand. Min RL	LANmark-OF Pre-Term
<i>Multimode</i>				
SC/PC	0,75 dB	0.35 dB	20dB	35 dB
LC/PC	0,75 dB	0.35 dB	20dB	35 dB
ST/PC	0,75 dB	0.35 dB	20dB	35 dB
MT-RJ/PC	0,75 dB	0.35 dB	20dB	35 dB
<i>Single Mode</i>				
SC/PC	0,75 dB	0.35 dB	20dB	50 dB
LC/PC	0,75 dB	0.35 dB	20dB	50 dB
ST/PC	0,75 dB	0.35 dB	20dB	50 dB
MT-RJ/PC	0,75 dB	0.35 dB	20dB	35 dB

LANmark-OF OM3, OM4, Singlemode (OS2) Fibre Assembly

N-number codification: N155F.TAACFCFPXXX

F: Fibre type	4: Singlemode (OS2) with G652D
	5: OM3 fibre
	7: OM4 fibre
AA: fibre count	06: 6 fibres
	12: 12 fibres
	24: 24 fibres
C: Connector type	L: LC
	C: SC
	T: ST
	M: MTRJ
F: Fan-out type	9: 900 um fanout
	2: 2.0 mm fanout
P: pulling eye	A: one side
	Y: both sides
	N: no pulling eye
XXX	length in meter

MPO System

MPO-concept

The Nexans' Plug&Play concept is specially designed for the LAN and data centre environment. It facilitates fast installation of a large number of fibre connections, high density, quick changes with limited down time and an easy migration path to future applications.

The Plug&Play system consists of 3 subcomponents: the MPO-MPO Pre-Term, the Plug&Play modules and the Plug&Play patch panel.

The MPO-MPO Pre-Term provides the connectivity between 2 Plug&Play modules installed in the Plug&Play patch panels in 2 different racks. The MPO connector allows to quickly connecting the 12 fibres of the MPO-MPO Pre-Term at the back of each Plug&Play module. Inside the Plug&Play module the fibres are spread out towards the SC/LC connectors at the front.



Optical performance and polarity method

Nexans' Plug&Play modules and fibre assemblies are available in 2 performance grades: LANmark-OF MPO connectivity and the newly introduced LANmark-OF MPO low loss connectivity. With the low loss connectivity insertion loss has been reduced by 40 %. It enables more complex data centre configurations, extended reach, more head room and a migration path to 40G/100G.

The fibre assemblies are available as LANmark-OF OM3 and LANmark-OF OM4 for extended reach. The Plug&Play modules have LANmark-OF OM4 performance and are backwards compatible with LANmark-OF OM3.

With LANmark-OF OM4 and the low loss solution up to 8 modules can be installed for an operational 10G channel. For 40G/100G a 4 connector channel up to 120 m can be supported.

Polarity in the optical channel during installation is guaranteed due to a pair flip fibre construction. This is in agreement with standard TIA 568-B-1-7-2006 method C. It allows the continuous use of the standard patch cord eliminating the need to buy optically straight and crossed patch cords. Also polarity is maintained with the same type of cassette on both sides of the channel without the need to flip the cassette on one side.

Pre-Term assemblies

The Pre-Term assemblies are based on the advanced Micro-Bundle technology. A Micro-Bundle is a small and very flexible tube with 12 fibres and it is the central part of a range of new cable designs. With its small diameter and short bending radius Micro-Bundle cables meet the tight space requirements in data centres.

The Micro-Bundle technology has extremely low skew by its advanced manufacturing process and small diameter. The Pre-Term assemblies easily exceed the skew requirements for 40G and 100G Ethernet.

With the high fibre count of the Pre-Term trunk assemblies the number of installed cables in a data centre can be reduced. The Pre-Term trunks are available in 12, 24, 48 and 96 fibre counts. The trunk assemblies are very robust due to its central strength element and the aramid yarns, but have still a small diameter of maximum 6.4 mm and a small bending radius of maximum 65 mm. The very flexible MPO fan-out is easy to install in a patch panel. Additional features are a pulling eye and a protective tube.

The slim Pre-Term is available as a 12 core assembly. The small diameter of this solution makes it the preferred solution when space constraints in the cable trays and the racks are key concerns.

To allow the customer the full choice of configuration options cable assemblies are offered with both normal and low loss connectors. The assemblies are available in both LANmark-OF OS2, OM3 and OM4.

Plug&Play Patch Panel and modules

The new Plug&Play patch panels accommodate high density patching with installation of up to 4 Plug&Play modules. A maximum of 96 LC connections can be installed in one height unit. The patch panels are sliding and have an integrated patch cord guide that sits in front of the modules.

One patch panel (N441.2MPP) is optimised for the installation of the slim Pre-Term. The newly introduced Plug&Play patch panel (N439.3MPP) has optimised slots in the back of the panel for the fixation of the Pre-Term trunks with cable glands.

The modules are available in 3 configurations: 12 SC, 12 LC and 24 LC. Modules with 24 LC connections support very high density solutions, while a module with 12 LC adaptors facilitates the patching.

Modules are available in Singlemode OS2 and multimode LANmark-OF OM4, both in normal LANmark-OF MPO connectivity and low loss performance.

LANmark-OF MPO-MPO Pre-Term Trunk for Singlemode OS2, OM3 and OM4

- Factory terminated MPO-MPO fibre assembly
- Flexible fan-out for ease of installation in patch panel
- Small cable diameter reduces required data centre space
- Polarity in optical channel is easily maintained by its advanced design
- Only one type of patch cords and one type of cassettes required
- Fibre count between 12 and 96
- Strong fibre assembly with pulling eye
- Fibre type: Singlemode (OS2), OM3 and OM4
- LANmark-OF MPO and low loss MPO connectivity performance

Description

MPO-MPO Pre-Term characteristics

The Pre-Term is based on an advanced Micro-Bundle design for the cable. The central strength element and the aramid yarns result in a mechanical strong cable, while the Micro-Bundle allow to reduce the diameter of the cable.

This round cable design facilitates the installation of the MPO-MPO Pre-Term: the small bending radius in any direction eliminates the problems of preferential bending associated with traditional ribbon MPO cables.

The small diameter of 5.4 mm for cables up to 48 fibres and of 6.4 mm for the cable with 96 fibres of the cable reduces significantly the expensive space required for cabling in a data centre and facilitates the airflow. The small diameter also reduced the weight of the cable putting less requirements on the cable trays.

The Pre-Term is delivered with protecting tubes around the installed MPO-connectors and with a pulling eye on one side. This pulling eye is connected to the internal strength element of the cable.

The MPO fan-out starts at 50 cm from the cable gland and every next connector is 12 cm further away from the cable gland. For the 96 core the MPO connectors are grouped by 2 for easy installation in the patch panel and the distance between 2 pairs of MPO connectors is 12 cm.

The Pre-Term is available with OM3, OM4 and singlemode fibres. The singlemode fibres are according the specifications for G652D and OS2 cables. Details on the fibre specifications can be found in the detailed fibre datasheets.

The typical value for the insertion loss for a normal loss MPO-MPO connection is 0,3 dB. The limit value is 0,6 dB measured according to standard IEC61300-3-45.

The typical value for the insertion loss for a low loss MPO-MPO connection is 0,2 dB. The limit value is 0,35 dB measured according to standard IEC61300-3-45.

Polarity in the optical channel during installation is guaranteed due to a pair flip fibre construction. This is in agreement with standard TIA 568-B-1-7-2006 method C. It allows the continuous use of the standard patch cords eliminating the need to buy optically straight patch cords. Also polarity is maintained with the same type of cassette on both sides of the channel without the need to flip the cassette on one side.

The MPO-MPO Pre-Term has standard non-pinned (female) connectors. This



LANmark-OF

Standards

International ISO11801:2002/ A1:2008



Mechanical resistance to impacts
10 impacts of 1 N.m



Operating temperature, range
-10 .. 60 °C

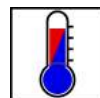

Storage temperature, range
-20 .. 60 °C



Fire retardant
IEC 60332-3



Flame retardant
IEC 60332-1

LANmark-OF MPO-MPO Pre-Term Trunk for Singlemode OS2, OM3 and OM4

matches with the pinned (male) connectors in the MPO cassettes.

The Pre-Term meets the requirements for flame non propagation (IEC 60332-1) and fire non-propagation (IEC 60332-3). The outer jacket of the pre-term is LSZH.

The MPO-MPO Pre-Term are custom made to the required customer length.

Consistent quality

In order to produce high quality, reliable pre-terminated multi-fibre cables, there are a number of physical characteristics that must be addressed. Therefore, all LANmark-OF MPO-MPO Pre-Term are fully terminated and tested in a quality assured factory environment. They are delivered with these test results.

Characteristics

Mechanical characteristics	
Maximum tensile load	1000 N
Max. Load. Long Term	250.0 N
Crush resistance (IEC 60794-1-E3)	100 N/cm
Mechanical resistance to impacts	10 impacts of 1 N.m
Usage characteristics	
Operating temperature, range	-10 .. 60 °C
Storage temperature, range	-20 .. 60 °C
Fire retardant	IEC 60332-3
Flame retardant	IEC 60332-1



Mechanical resistance to impacts
10 impacts of 1 N.m



Operating temperature, range
-10 .. 60 °C

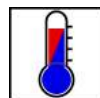

Storage temperature, range
-20 .. 60 °C



Fire retardant
IEC 60332-3



Flame retardant
IEC 60332-1

LANmark-OF MPO-MPO Pre-Term Trunk for Singlemode OS2, OM3 and OM4

Insertion loss for individual MPO connection

Fibre type	Multimode (OM3 or OM4)	Singlemode (OS2 with G652D)
Normal loss connection - Typical loss	0.3 dB	0.3 dB
Normal loss connection - Max loss	0.6 dB	0.6 dB
Low loss connection - Typical loss	0.15 dB	0.15 dB
Low loss connection - Max loss	0.35 dB	0.35 dB

Measured in manufacturing according to standard IEC 61300-3-45

N-number codification: N15A.MK KP V XXX

Letter in N-number	Description	Variations
A	Fibre type	4: SM (OS2) or 5: OM3, 7: OM4
KK	Fibre count	12,24, 48 or 96
P	Performance	Normal (S) or low loss (L)
V	Fanout type	A: pulling eye one side + first MPO at 50 cm + sequential MPO every 12 cm (12, 24 and 48 fibres) E: pulling eye one side + first 2 MPO at 50 cm + sequential 2 MPO every 12 cm (96 fibres)
XXX	Length between glands	001-300 m

Example: N155.M48LA050: LANmark-OF MPO-MPO Pre-Term with 48 OM3 fibres, low loss connectors, pulling eye on one side, first MPO connector at 50 cm from cable gland and with a length of 50 m between the cable glands

Cable Characteristics

Fibre count	12F/24F/48F	96F
Cable Diameter	5.4 mm	6.4 mm
Cable Weight (kg/km)	31 kg	50 kg
Minimum bending radius during installation	80 mm	100 mm
Minimum bending radius installed	65 mm	65 mm

LANmark-OF MPO-MPO Slim Pre-Term for Singlemode (OS2), OM3 and OM4

- Factory terminated MPO-MPO fibre assembly
- Easy installation of Pre-Term since assembly can bend in any direction.
- Small diameter of cable to reduce data centre space
- Polarity in optical channel is easily maintained by its advanced design
- Only one type of patch cords and one type of cassettes required
- 12 fibres
- Fibre type: Singlemode (OS2), OM3 and OM4
- Normal and low loss connectivity

Description

MPO-MPO Pre-Term characteristics

The round cable design facilitates the installation of the MPO-MPO Pre-Term: the small bending radius of only 30 mm in any direction eliminates the problems of preferential bending associated with traditional ribbon MPO cables.

Polarity in the optical channel during installation is guaranteed due to a pair flip fibre construction. This is in agreement with standard TIA 568-B-1-7-2006 method C. It allows the continuous use of the standard patch cords eliminating the need to buy optically straight patch cords. Also polarity is maintained with the same type of cassette on both sides of the channel without the need to flip the cassette on one side.

The Pre-Term is available with OM3, OM4 and singlemode fibres. The singlemode fibres are according to the specifications for G652D and OS2 cables. Details on the fibre specifications can be found in the detailed fibre datasheets.

The typical value for the insertion loss for a normal loss MPO-MPO connection is 0,3 dB. The limit value is 0,6 dB measured according to standard IEC61300-3-45.

The typical value for the insertion loss for a low loss MPO-MPO connection is 0,2 dB. The limit value is 0,35 dB measured according to standard IEC61300-3-45.

Mechanical characteristics of the Pre-Term are conform to the IEC-60794-20 standard for indoor cables.

The small diameter of 2.5 mm of the cable reduces significantly the expensive space required for cabling in a data centre and facilitates the airflow.

The MPO-MPO Pre-Term has standard non-pinned (female) connectors. This matches with the pinned (male) connectors in the MPO modules.

Consistent quality

In order to produce high quality, reliable pre-terminated multi-fibre cables, there are a number of physical characteristics that must be addressed. Therefore, all LANmark-OF MPO-MPO Pre-Term are fully terminated and tested in a quality assured factory environment. They are delivered with these test results.

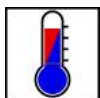

Operating temperature, range
0 .. 50 °C



Storage temperature, range
-40 .. 60 °C



Fire retardant
IEC 60332-3



Flame retardant
IEC 60332-1



Minimum static operating bending radius
30 mm

LANmark-OF MPO-MPO Slim Pre-Term for Singlemode (OS2), OM3 and OM4

MPO-MPO Pre-Term Benefits

- Short & reliable manufacturing lead-time
- Fast installation times
- No specialised termination training required
- No consumables, termination tool kits
- No cable preparation necessary
- No cable or connector scrap
- No termination errors on site
- Delivered fully tested, labelled and documented
- Improved end-to-end attenuation
- Reduced on-site disruption and installation time
- Cost effective solution

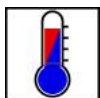

Operating temperature,
range
0 .. 50 °C



Storage temperature,
range
-40 .. 60 °C



Fire retardant
IEC 60332-3



Flame retardant
IEC 60332-1



Minimum static operating
bending
radius
30 mm

LANmark-OF MPO-MPO Slim Pre-Term for Singlemode (OS2), OM3 and OM4

Characteristics

Dimensional characteristics	
Approximate weight	5.5 kg/km
Outer Diameter	2.5 mm
Mechanical characteristics	
Maximum pulling force (IEC 60794-1-2-E1)	400 N
Crush resistance (IEC 60794-1-E3)	50 N/cm
Usage characteristics	
Operating temperature, range	0 .. 50 °C
Storage temperature, range	-40 .. 60 °C
Fire retardant	IEC 60332-3
Flame retardant	IEC 60332-1
Minimum static operating bending radius	30 mm

Insertion loss for individual MPO connection

Fibre type	Multimode (OM3 or OM4)	Singlemode (OS2 with G652D)
Normal loss connection - Typical loss	0.3 dB	0.3 dB
Normal loss connection - Max loss	0.6 dB	0.6 dB
Low loss connection - Typical loss	0.15 dB	0.15 dB
Low loss connection - Max loss	0.3 dB	0.3 dB

Measured in manufacturing according to standard IEC 61300-3-45

N-number codification: N15A.P12QVXXX

Letter in N-number	Description	Variations
A	Fibre type	4: SM (OS2) or 5: OM3, 7: OM4
Q	Performance	Normal (S) or low loss (L)
V	Fanout type	Default (N): No pulling eye and protection tube
XXX	Length between glands	001-300 m

Example: N155.P12LN050: LANmark-OF MPO-MPO Slim Pre-Term with 12 OM3 fibres, low loss connectors with a length of 50 m between the cable glands.

LANmark-OF Plug&Play Patch Panels

- Optical patch panels that holds up 4 MPO modules in 1 HU
- Sliding patch panels for ease of installation, upgrade and maintenance
- High density connectivity: up to 48 SC or 96 LC depending on module type.
- Labelling front for port identification and patch cord management within 1 HU

Description

Plug&Play Concept Description

The Nexans' Plug and Play concept is specifically designed for installation in data centres where the high density, integrated patch cord guide and enhanced installation benefits of the patch panel meet the key requirements for implementation. It allows quick changes with limited down time, easy migration to other applications and a transition path to 40G.

The Plug&Play system consists of 3 subcomponents: Plug&Play modules, the MPO-MPO Pre-Term and the Plug&Play patch panel.

The modules provide the transition between the MPO-MPO Pre-Term and the active devices: the Pre-Term connects to the back of the module and inside the module the fibres are spread out towards the SC/LC connectors at the front. Modules are available in a wide variety of port counts and connector style.

Plug&Play Patch Panel Characteristics

The Nexans unique patch panel design allows to hold up to 4 MPO cassettes in 1HU of the distribution rack. Depending on the type of the module a high density of up to 96 fibre connections can be accommodated.

The new patch cord guide sits in front of the modules and allows the patch cords to be managed within the same 1 HU saving expensive rack space.

The patch cord guide also provides a labelling facility to identify connections. Additional labelling is provided by printed port numbers on the modules.

The newly developed trays slide for improved access to install new modules and to fix the MPO-MPO Pre-Term easily. The front of the patch panel can be fixed in a flush or recessed position in the rack.

The N439.2MPP is optimised for installation of the trunk MPO-MPO Pre-Term: the cable glands of the Pre-Term allow a fast and solid fixation of the cable. There is ample space inside the patch panel to organise the flexible fan-out of the MPO-MPO Pre-Term.

The N441.2MPP is optimised for installation of multiple slim Pre-Terms. The slim Pre-Terms are fixed with tie wraps.

Panels are fully painted in black for a professional look and feel.

Blank fillers (N441.2MBP) are available as separate accessories for unused positions to give a finished look.

**LANmark-OF**

Standards

International ISO/IEC 11801

LANmark-OF Plug@Play Module

- Play@Play module with 12SC, 12 LC or 24 LC connections
- Available with LANmark-OF Plug@Play connectivity and low loss connectivity grade
- Available in LANmark-OF OM4 multimode and LANmark-OF OS2 singlemode
- Module can be easily mounted into Nexans' Plug&Play patch panel
- High density: 4 modules fit into 1U
- Plug@Play modules are pre-installed and 100 % factory tested

Description

The Plug@Play system consists of 3 subcomponents: the MPO modules, the MPO-MPO Pre-Terms and the Plug&Play patch panel.

The central component is the pre-installed Plug@Play module. The MPO connector at the back of the module connects at once 12 fibres of the MPO-MPO Pre-Term. Inside the module the fibres are spread out towards the SC/LC adaptors at the front.

Plug@Play Module Characteristics

Up to 4 Plug@Play modules can be installed quickly into the Plug&Play patch panel with push rivets. With these 4 modules a medium density of 48 SC or 48 LC connections within 1U can be achieved. With the 24 LC high density module a maximum of 96 LC connections within 1U is also possible.

The insertion loss for the LANmark-OF Plug@Play module is 0,9 dB measured according to standard IEC 61300-3-45.

The insertion loss for the LANmark-OF Plug@Play low loss module is 0,6 dB measured according to standard IEC 61300-3-45.

The modules are available with OM4 fibres for multimode and are backwards compatible with OM3 fibres. The singlemode module has G652D fibres for OS2 compatibility.

The wiring inside the module is straight. This allows to maintain polarity in the MPO-link together with the pair-wise fibre flip inside the MPO-MPO Pre-Term according to method C from standard TIA 568-B-1-7-2007.

Since all connectivity is factory installed and factory tested installation times are short for a quick deployment or for frequent changes.

The Plug@Play module has standard pinned (male) connectors. This matches perfectly with the non-pinned (female) connectors of the MPO-MPO Pre-Term.



LANmark-OF

Standards

International ISO/IEC 11801

LANmark-OF Plug@Play Module

N-numbers for Plug&Play Modules

MPO Module	OM3/OM4	N441.2M24LC4	LANmark-OF Plug&Play Module 24 LC OM4
		N441.2M12LC4	LANmark-OF Plug&Play Module 12 LC OM4
		N441.2M12SC4	LANmark-OF Plug&Play Module 12 SC OM4
	SM OS2	N441.2M24LC0	LANmark-OF Plug&Play Module 24 LC Singlemode
		N441.2M12LC0	LANmark-OF Plug&Play Module 12 LC Singlemode
		N441.2M12SC0	LANmark-OF Plug&Play Module 12 SC Singlemode
MPO Low Loss Module	OM3/OM4	N441.2L24LC4	LANmark-OF Plug&Play Low Loss Module 24 LC OM4
		N441.2L12LC4	LANmark-OF Plug&Play Low Loss Module 12 LC OM4
		N441.2L12SC4	LANmark-OF Plug&Play Low Loss Module 12 SC OM4
	SM OS2	N441.2L24LC0	LANmark-OF Plug&Play Low Loss Module 24 LC Singlemode
		N441.2L12LC0	LANmark-OF Plug&Play Low Loss Module 12 LC Singlemode
		N441.2L12SC0	LANmark-OF Plug&Play Low Loss Module 12 SC Singlemode

Fibre Patch Panels

LANmark-OF offers cutting edge hardware products including patch panels, zone distribution boxes and outlets.

Each product has been thoroughly developed to ensure best system offering while meeting stringent international standards.

Modular concept

The fully modular design allows mixing of different Snap-in adaptor types : LC, MT-RJ and SC. Benefits: up to 24 fibres for the Zone Distribution Box and 48 for the Patch Panel. Both are compatible for loose tube and tight buffer cables.

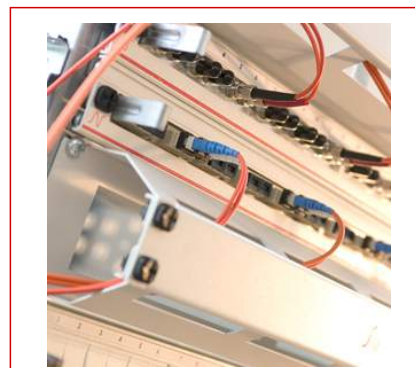

LANmark-OF Sliding Patch Panels

- Empty OF patch panels with sliding mechanism.
- Suitable for direct termination or splicing.
- Available in two versions 24 ST or modular Duplex or simplex SC, LC, or MT-RJ snap-ins.
- Inner sliding to respect bending radius of patch cord.
- LANmark look.

Description

Application

Accepting the range of ST couplers or LANmark-OF snap-ins, these patch panels with sliding mechanism facilitate front side installation.

Compatibility

Suitable for tight buffer cables (direct termination) , Loose tube cables using Splice Cassette / pigtailed terminations. Accepts pre-terminated cable assemblies.

Installation

- 19" width. 1U
- Accommodates 24 ST or 24 LANmark-OF snap-ins (or 12DSC).
- 2 positions : flush or recessed with respect of cable bend radius.
- Comes with marking strips to number and categorise ports.

**LANmark-OF**

Standards

International ISO/IEC 11801

LANmark-OF Sliding Patch Panels

Product List

☎ = Make to order, 📦 = Make to stock

Nexans ref.	Name
📦 N441.204 Nouveauté	LANmark-OF Patch Panel Snap-In Sliding Black
📦 N441.203 Nouveauté	LANmark-OF Patch Panel Snap-In Sliding White
📦 N441.201	LANmark-OF Patch Panel 24 ST Sliding White

☎ = Make to order, 📦 = Make to stock

LANmark-OF Sliding Preloaded Patch Panels

- Preloaded patch panels with adaptors for fast installation in data centres
- High density connectivity: up to 48 SC or 96 LC.
- Sliding and tilting patch panel for ease of installation, upgrade and maintenance
- Optimised for installation of Pre-Term with a cable gland and fibre management features
- Improved splice cassettes with lifting functionality for improved ease of installation and inspection
- Labelling facility for port identification and patch cord management within 1 U

Description

The new pre-loaded patch panel is specifically designed for installation in data centres where the high density, integrated patch cord guide and enhanced installation benefits of the patch panel meet the key requirements for implementation.

The patch panels are pre-loaded with SC or LC adaptors and are available in medium and high density versions. The medium density patch panel provides 24 SC or 48 LC connections, while the high density version has 48 SC or 96 LC connections. Singlemode and multimode versions are available.

The new patch cord guide sits in front of the adaptors and allows the patch cords to be managed within the same 1 U saving expensive rack space.

The patch cord guide also provides a labelling facility to identify connections. Additional labelling is provided by printed port numbers on the adaptor plate.

The newly developed chassis of the patch panel can be removed from the rack completely to ease installation of direct terminated or spliced fibre and faster installation of pre-terminated cables. The tray tilts and slides for improved access to the installed fibres for inspection.

The pre-loaded patch panel has extended cable management with multiple entries to provide maximum flexibility. It accommodates both cable glands and tie wraps for strain relief of the cables. The cable gland sizes are 20 mm (8x) and 25 mm (2x).

For improved fibre management the fibres can be arranged in 4 separate loops for added flexibility and organisation. The support bases and the rings for these 4 loops are included.

The patch panel chassis has multiple, specially designed, slots at the rear to fix the cable glands of Nexans' pre-terminated cables. There is ample space inside the patch panel to organise the flexible fan-out of the pre-terminated cables.

Up to 4 splice cassettes (N890.090 and N890.091) can be installed inside the tray of the patch panel. Only one cover (N890.093) is required to close the splice cassettes at the top. The bottom splice cassette is fixed with screws to the chassis of the patch panel. Splice cassettes are fixed with hinges to the cassette below and with such an installation the splice cassettes can be lifted and tilted for improved access to the splices inside the patch panel. This facilitates the inspection of the splices after installation.

Each splice cassette for heat shrink protectors (N890.090) can accommodate 12 splices allowing a maximum of 48 splices for the complete patch panel.

The splice cassette for aluminium protectors (N890.091) has a maximum of 24 splices resulting in a maximum of 96 splices per patch panel. N890.091 can only be used with maxistrip pigtailed cables with 250 um fibres.

Splice cassettes are not included in the patch panel.

The front adaptor plate can be fixed in a flush or recessed position in the rack using the adjustable side brackets. When the panel is installed recessed the distance between the rack vertical and the rear of the panel is 288 mm. The front cord management projection is 67 mm. When the panel is installed flush the distance between the rack vertical and the rear of the panel is 248 mm. The front cord management projection is 107 mm.



LANmark-OF

Standards

International ISO/IEC 11801

LANmark-OF Sliding Preloaded Patch Panels

Panels are fully painted in black for a professional look and feel.

LANmark-OF Sliding Preloaded Patch Panels

Available versions and N-numbers

N-number	Description	SC or LC	# connections	SM or MM
N439.2B48LCMM	LANmark-OF Preloaded Patch Panel 48 LC Multimode Sliding Black	LC	48	MM
N439.2B48LCSM	LANmark-OF Preloaded Patch Panel 48 LC Singlemode Sliding Black	LC	48	SM
N439.2B96LCMM	LANmark-OF Preloaded Patch Panel 96 LC Multimode Sliding Black	LC	96	MM
N439.2B96LCSM	LANmark-OF Preloaded Patch Panel 96 LC Singlemode Sliding Black	LC	96	SM
N439.2B24SCMM	LANmark-OF Preloaded Patch Panel 24 SC Multimode Sliding Black	SC	24	MM
N439.2B24SCSM	LANmark-OF Preloaded Patch Panel 24 SC Singlemode Sliding Black	SC	24	SM
N439.2B48SCMM	LANmark-OF Preloaded Patch Panel 48 SC Multimode Sliding Black	SC	48	MM
N439.2B48SCSM	LANmark-OF Preloaded Patch Panel 48 SC Singlemode Sliding Black	SC	48	SM

Essential-OF Fixed Patch Panel

- Empty OF patch panel without sliding mechanism.
- Suitable for direct termination or splicing.
- Can be used as splitter box.
- Available in two versions 24ST and 24 SC.
- Three positions faceplate for patch cord bending radius.

Description

Application

Nexans Essential 1U Optical Fibre Patch Panel has been designed to support :

- up to 24 ST ports or
- up to 12 Dual SC ports.

It combines a cost effective design with high port density. It is suitable for tight buffer cables (direct termination) or loose tube cables using splice tray (N890.001).

It also can be used as a splitter(*)

Features

- 19" width
- Two versions ST and SC
- Blind face plates are available.
- 3 positions :

-flushed

-15 mm recessed

-30 mm recessed

- Easy identification : couplers are numbered on the face plate.
- Cable entrance is possible through a cable gland (PG16) or through a rectangular opening (Using tie wraps).
- Cage-nuts as well as fibre holders are included.

(*) splitter allows to split multitube cable to at most 6 Nexans E-ssential OF Patch Panels.

For use as splitter, you need:

-Splitter tube (N890.044)

-Cable gland for splitter (N890.043)

-Blind plate (N441.132)



essential

Standards

International ISO/IEC 11801

Essential-OF Fixed Patch Panel

Characteristics

Dimensional characteristics

Heightunit	1 U
Width	19 in
Depth	233 mm

Usage characteristics

Component function	Patch panel
--------------------	-------------

Product List

Nexans ref.	Name	Connector type
 N441.122	Essential-OF Patch Panel 24 SC White	SC
 N441.121	Essential-OF Patch Panel 24 ST White	ST

 = Make to order,  = Make to stock

Outlets

LANmark-OF Zone Distribution box

- Empty ZD box optical fiber
- Suitable for direct termination or splicing.

Description

Application

- Designed for the installation of zone wiring, fibre to the office and to the desk

Compatibility

Suitable for tight buffer cable (direct termination) or loose tube using splice tray

Compatible with all LANmark-OF accessories

Installation

The OF zone distribution box is easy to install in the ceiling, false floor or on the wall with four fixation points in the bottom plate.

To enter the cable there is a pre-perforated hole for a cable gland PG 16 foreseen, at the backside.

There is a fixation point for the Nexans splice tray.

Printed numbering system on the cover

**LANmark-OF**

Standards

International ISO/IEC 11801

LANmark-OF Zone Distribution box

Characteristics

Dimensional characteristics

Depth	200 mm
Height	40 mm
Width	230 mm



Usage characteristics

Field of application	Indoor
Packaging	Box

Characteristics ZD box

Connector type	LC
-----------------------	-----------

Product List

Nexans ref.	Name
 N521.630	LANmark-OF modular Zone distribution box empty
 = Make to order,  = Make to stock	

Structural Hardware

- For all 45x45mm fittings
- Fits Surface Mount Boxes, Cover plates and Ducts
- Outlets include labeling and shutters
- Suitable for all snap-in adaptors.
- Easy click-in mechanism.

Description

Application

This range of outlets is suitable for any environment: ducts, cover plates and surface mount boxes (including 45 fittings). The range features Snap-in adaptors for fast and easy installation.

For the specific information on the Snap-in adaptors, refer to the corresponding datasheets.

Guarantees

- All plastic material is UL 94V0

Installation

These modular outlets fit into a complete range of international 45x45 covering plates and surface mount boxes.

For easy management and identification, the outlets include an integrated outlet labelling system using transparent windows.

The Snap-in connectors are inserted into the modular outlet by a simple click-in mechanism.

**LANmark-OF**



Standards

International ISO/IEC 11801

Structural Hardware

Product List

Nexans ref.	Name
 N420.035 Nouveauté	Modular OF Splicing Outlet 45X45 for 2 Snap-in adaptors

 = Make to order,  = Make to stock

Patch Cords

LANmark-OF Patch Cords

Description

Application

Nexans **LANmark-OF** optical fibre patchcords have been designed for applications where a high level of optical features is required.

- Suitable for use in cabinets to connect patch panels/active equipments to active equipments.
- Suitable for use in the work area to connect the work station to the wall outlet (Fibre To The Desk).

Applications support :

- Fast Ethernet 100 base FX
- 1Gbase SX
- 1Gbase LX
- 10Gbase SR
- 10Gbase LW
- 10Gbase LX4
- 10Gbase LR
- 10Gbase LRM
- Fibre Channel Serial 1G
- Fibre Channel Serial 2G
- Fibre Channel Serial 4G
- Fibre Channel Serial 10G



LANmark-OF

Standards

International ISO/IEC 11801

Performance

Nexans **LANmark-OF** patchcords are available in all standardised optical fibre classes, multimode and single mode. The MM62.5 version is designed for use in an OM1 compliant system, the MM50 version for OM2 systems and the MM50 OM3 version for OM3 systems. The singlemode version is OS2 compliant. The multimode versions can be used in laser optimised systems using the **LANmark-OF xt** cables.

Design

Nexans **LANmark-OF** patchcords designed according the "Cross-Over" wiring principle to improve field installation (A1-B2, B1-A2).

Guarantees

Nexans **LANmark-OF** patchcords are guaranteed to support LED based applications as well as Laser based applications. They are covered by Nexans warranty as described in the General Terms and Conditions.

Characteristics

Construction characteristics

Armour type	Aramid yarn
Outer sheath	LSZH-FR

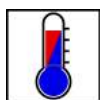

Operating temperature, range
-10 .. 50 °C



Fire retardant
IEC 60332-3 Cat.C



Minimum static operating bending radius
40 mm

LANmark-OF Patch Cords

Mechanical characteristics

Maximum pulling force by laying	0.2 kN
Crush resistance (IEC 60794-1-E3)	250 N/cm

Usage characteristics

Operating temperature, range	-10 .. 50 °C
Fire retardant	IEC 60332-3 Cat.C
Minimum static operating bending radius	40 mm

Product List

☎ = Make to order, 📦 = Make to stock

Nexans ref.	Name	Length (m)	Fiber optic type	Connector type
📦 N123.2LLO2	LANmark-OF Patch cord Multimode 50/125 2LC - 2LC LSZH Orange 2m	2	OM2 50/125 Extended Distance	LC
☎ N123.2LLO5	LANmark-OF Patch cord Multimode 50/125 2LC - 2LC LSZH Orange 5m	5	OM2 50/125 Extended Distance	LC
📦 N123.2CLO2	LANmark-OF Patch cord Multimode 50/125 2LC - 2SC LSZH Orange 2m	2	OM2 50/125 Extended Distance	SC-LC
☎ N123.2CLO5	LANmark-OF Patch cord Multimode 50/125 2LC - 2SC LSZH Orange 5m	5	OM2 50/125 Extended Distance	SC-LC
☎ N123.2LTO2	LANmark-OF Patch cord Multimode 50/125 2LC - 2ST LSZH Orange 2m	2	OM2 50/125 Extended Distance	LC
☎ N123.2LTO5	LANmark-OF Patch cord Multimode 50/125 2LC - 2ST LSZH Orange 5m	5	OM2 50/125 Extended Distance	LC
📦 N123.2CCO2	LANmark-OF Patch cord Multimode 50/125 2SC - 2SC LSZH Orange 2m	2	OM2 50/125 Extended Distance	SC
📦 N123.2CCO5	LANmark-OF Patch cord Multimode 50/125 2SC - 2SC LSZH Orange 5m	5	OM2 50/125 Extended Distance	SC
📦 N123.2CTO2	LANmark-OF Patch cord Multimode 50/125 2SC - 2ST LSZH Orange 2m	2	OM2 50/125 Extended Distance	SC
☎ N123.2CTO5	LANmark-OF Patch cord Multimode 50/125 2SC - 2ST LSZH Orange 5m	5	OM2 50/125 Extended Distance	SC
☎ N123.2TTO2	LANmark-OF Patch cord Multimode 50/125 2ST - 2ST LSZH Orange 2m	2	OM2 50/125 Extended Distance	ST
☎ N123.2TTO5	LANmark-OF Patch cord Multimode 50/125 2ST - 2ST LSZH Orange 5m	5	OM2 50/125 Extended Distance	ST
☎ N123.2MLO2	LANmark-OF Patch cord Multimode 50/125 MT-RJ - 2LC LSZH Orange 2m	2	OM2 50/125 Extended Distance	MT-RJ
☎ N123.2MLO5	LANmark-OF Patch cord Multimode 50/125 MT-RJ - 2LC LSZH Orange 5m	5	OM2 50/125 Extended Distance	MT-RJ
☎ N123.2MCO2	LANmark-OF Patch cord Multimode 50/125 MT-RJ - 2SC LSZH Orange 2m	2	OM2 50/125 Extended Distance	MT-RJ
☎ N123.2MCO5	LANmark-OF Patch cord Multimode 50/125 MT-RJ - 2SC LSZH Orange 5m	5	OM2 50/125 Extended Distance	MT-RJ
☎ N123.2MTO2	LANmark-OF Patch cord Multimode 50/125 MT-RJ - 2ST LSZH Orange 2m	2	OM2 50/125 Extended Distance	MT-RJ

☎ = Make to order, 📦 = Make to stock

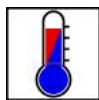
 Operating temperature, range
 -10 .. 50 °C

 Fire retardant
 IEC 60332-3 Cat.C

 Minimum static operating bending radius
 40 mm

LANmark-OF Patch Cords

Nexans ref.	Name	Length (m)	Fiber optic type	Connector type
☎ N123.2MTO5	LANmark-OF Patch cord Multimode 50/125 MT-RJ - 2ST LSZH Orange 5m	5	OM2 50/125 Extended Distance	MT-RJ
☎ N123.2MMO2	LANmark-OF Patch cord Multimode 50/125 MT-RJ - MT-RJ LSZH Orange 2m	2	OM2 50/125 Extended Distance	MT-RJ
☎ N123.2MMO5	LANmark-OF Patch cord Multimode 50/125 MT-RJ - MT-RJ LSZH Orange 5m	5	OM2 50/125 Extended Distance	MT-RJ
☎ N123.5LLO2	LANmark-OF Patch cord Multimode 50/125 OM3 2LC - 2LC LSZH Orange 2m	2	OM3 50/125 Extended Distance	LC
☎ N123.5LLO5	LANmark-OF Patch cord Multimode 50/125 OM3 2LC - 2LC LSZH Orange 5m	5	OM3 50/125 Extended Distance	LC
📦 N123.5CLO2	LANmark-OF Patch cord Multimode 50/125 OM3 2LC - 2SC LSZH Orange 2m	2	OM3 50/125 Extended Distance	SC-LC
☎ N123.5CLO5	LANmark-OF Patch cord Multimode 50/125 OM3 2LC - 2SC LSZH Orange 5m	5	OM3 50/125 Extended Distance	SC-LC
☎ N123.5LTO2	LANmark-OF Patch cord Multimode 50/125 OM3 2LC - 2ST LSZH Orange 2m	2	OM3 50/125 Extended Distance	LC
☎ N123.5LTO5	LANmark-OF Patch cord Multimode 50/125 OM3 2LC - 2ST LSZH Orange 5m	5	OM3 50/125 Extended Distance	LC
📦 N123.5CCO2	LANmark-OF Patch cord Multimode 50/125 OM3 2SC - 2SC LSZH Orange 2m	2	OM3 50/125 Extended Distance	SC
☎ N123.5CCO5	LANmark-OF Patch cord Multimode 50/125 OM3 2SC - 2SC LSZH Orange 5m	5	OM3 50/125 Extended Distance	SC
☎ N123.5CTO2	LANmark-OF Patch cord Multimode 50/125 OM3 2SC - 2ST LSZH Orange 2m	2	OM3 50/125 Extended Distance	SC
☎ N123.5CTO5	LANmark-OF Patch cord Multimode 50/125 OM3 2SC - 2ST LSZH Orange 5m	5	OM3 50/125 Extended Distance	SC
☎ N123.5TTO2	LANmark-OF Patch cord Multimode 50/125 OM3 2ST - 2ST LSZH Orange 2m	2	OM3 50/125 Extended Distance	ST
☎ N123.5TTO5	LANmark-OF Patch cord Multimode 50/125 OM3 2ST - 2ST LSZH Orange 5m	5	OM3 50/125 Extended Distance	ST
☎ N123.5MLO2	LANmark-OF Patch cord Multimode 50/125 OM3 MT-RJ - 2LC LSZH Orange 2m	2	OM3 50/125 Extended Distance	MT-RJ
☎ N123.5MLO5	LANmark-OF Patch cord Multimode 50/125 OM3 MT-RJ - 2LC LSZH Orange 5m	5	OM3 50/125 Extended Distance	MT-RJ
☎ N123.5MCO2	LANmark-OF Patch cord Multimode 50/125 OM3 MT-RJ - 2SC LSZH Orange 2m	2	OM3 50/125 Extended Distance	MT-RJ
☎ N123.5MCO5	LANmark-OF Patch cord Multimode 50/125 OM3 MT-RJ - 2SC LSZH Orange 5m	5	OM3 50/125 Extended Distance	MT-RJ
☎ N123.5MTO2	LANmark-OF Patch cord Multimode 50/125 OM3 MT-RJ - 2ST LSZH Orange 2m	2	OM3 50/125 Extended Distance	MT-RJ
☎ N123.5MTO5	LANmark-OF Patch cord Multimode 50/125 OM3 MT-RJ - 2ST LSZH Orange 5m	5	OM3 50/125 Extended Distance	MT-RJ
☎ N123.5MMO2	LANmark-OF Patch cord Multimode 50/125 OM3 MT-RJ - MT-RJ LSZH Orange 2m	2	OM3 50/125 Extended Distance	MT-RJ
☎ N123.5MMO5	LANmark-OF Patch cord Multimode 50/125 OM3 MT-RJ - MT-RJ LSZH Orange 5m	5	OM3 50/125 Extended Distance	MT-RJ

☎ = Make to order, 📦 = Make to stock

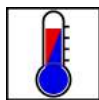
 Operating temperature, range
 -10 .. 50 °C

 Fire retardant
 IEC 60332-3 Cat.C

 Minimum static operating bending radius
 40 mm

LANmark-OF Patch Cords

Nexans ref.	Name	Length (m)	Fiber optic type	Connector type
☎ N123.0LLO2	LANmark-OF Patch cord Multimode 62,5/125 2LC - 2LC LSZH Orange 2m	2	OM1 62.5/125 Extended Distance	LC
☎ N123.0LLO5	LANmark-OF Patch cord Multimode 62,5/125 2LC - 2LC LSZH Orange 5m	5	OM1 62.5/125 Extended Distance	LC
📦 N123.0CLO2	LANmark-OF Patch cord Multimode 62,5/125 2LC - 2SC LSZH Orange 2m	2	OM1 62.5/125 Extended Distance	SC-LC
☎ N123.0CLO5	LANmark-OF Patch cord Multimode 62,5/125 2LC - 2SC LSZH Orange 5m	5	OM1 62.5/125 Extended Distance	SC-LC
☎ N123.0LTO2	LANmark-OF Patch cord Multimode 62,5/125 2LC - 2ST LSZH Orange 2m	2	OM1 62.5/125 Extended Distance	LC
☎ N123.0LTO5	LANmark-OF Patch cord Multimode 62,5/125 2LC - 2ST LSZH Orange 5m	5	OM1 62.5/125 Extended Distance	LC
📦 N123.0CCO2	LANmark-OF Patch cord Multimode 62,5/125 2SC - 2SC LSZH Orange 2m	2	OM1 62.5/125 Extended Distance	SC
📦 N123.0CCO5	LANmark-OF Patch cord Multimode 62,5/125 2SC - 2SC LSZH Orange 5m	5	OM1 62.5/125 Extended Distance	SC
📦 N123.0CTO2	LANmark-OF Patch cord Multimode 62,5/125 2SC - 2ST LSZH Orange 2m	2	OM1 62.5/125 Extended Distance	SC
☎ N123.0CTO5	LANmark-OF Patch cord Multimode 62,5/125 2SC - 2ST LSZH Orange 5m	5	OM1 62.5/125 Extended Distance	SC
📦 N123.0TTO2	LANmark-OF Patch cord Multimode 62,5/125 2ST - 2ST LSZH Orange 2m	2	OM1 62.5/125 Extended Distance	ST
☎ N123.0TTO5	LANmark-OF Patch cord Multimode 62,5/125 2ST - 2ST LSZH Orange 5m	5	OM1 62.5/125 Extended Distance	ST
☎ N123.0MLO2	LANmark-OF Patch cord Multimode 62,5/125 MT-RJ - 2LC LSZH Orange 2m	2	OM1 62.5/125 Extended Distance	MT-RJ
☎ N123.0MLO5	LANmark-OF Patch cord Multimode 62,5/125 MT-RJ - 2LC LSZH Orange 5m	5	OM1 62.5/125 Extended Distance	MT-RJ
📦 N123.0MCO2	LANmark-OF Patch cord Multimode 62,5/125 MT-RJ - 2SC LSZH Orange 2m	2	OM1 62.5/125 Extended Distance	MT-RJ
☎ N123.0MCO5	LANmark-OF Patch cord Multimode 62,5/125 MT-RJ - 2SC LSZH Orange 5m	5	OM1 62.5/125 Extended Distance	MT-RJ
☎ N123.0MTO2	LANmark-OF Patch cord Multimode 62,5/125 MT-RJ - 2ST LSZH Orange 2m	2	OM1 62.5/125 Extended Distance	MT-RJ
☎ N123.0MTO5	LANmark-OF Patch cord Multimode 62,5/125 MT-RJ - 2ST LSZH Orange 5m	5	OM1 62.5/125 Extended Distance	MT-RJ
☎ N123.0MMO2	LANmark-OF Patch cord Multimode 62,5/125 MT-RJ - MT-RJ LSZH Orange 2m	2	OM1 62.5/125 Extended Distance	MT-RJ
☎ N123.0MMO5	LANmark-OF Patch cord Multimode 62,5/125 MT-RJ - MT-RJ LSZH Orange 5m	5	OM1 62.5/125 Extended Distance	MT-RJ
☎ N123.4LLY2	LANmark-OF Patch cord Singlemode OS2 2LC - 2LC LSZH Yellow 2m	2	SM (G.652D)	LC
☎ N123.4LLY5	LANmark-OF Patch cord Singlemode OS2 2LC - 2LC LSZH Yellow 5m	5	SM (G.652D)	LC
📦 N123.4CLY2	LANmark-OF Patch cord Singlemode OS2 2LC - 2SC LSZH Yellow 2m	2	SM (G.652D)	SC-LC

☎ = Make to order, 📦 = Make to stock

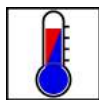

Operating temperature, range
-10 .. 50 °C



Fire retardant
IEC 60332-3 Cat.C



Minimum static operating bending radius
40 mm

LANmark-OF Patch Cords

Nexans ref.	Name	Length (m)	Fiber optic type	Connector type
☎ N123.4CLY5	LANmark-OF Patch cord Singlemode OS2 2LC - 2SC LSZH Yellow 5m	5	SM (G.652D)	SC-LC
☎ N123.4LTY2	LANmark-OF Patch cord Singlemode OS2 2LC - 2ST LSZH Yellow 2m	2	SM (G.652D)	LC
☎ N123.4LTY5	LANmark-OF Patch cord Singlemode OS2 2LC - 2ST LSZH Yellow 5m	5	SM (G.652D)	LC
📦 N123.4CCY2	LANmark-OF Patch cord Singlemode OS2 2SC - 2SC LSZH Yellow 2m	2	SM (G.652D)	SC
☎ N123.4CCY5	LANmark-OF Patch cord Singlemode OS2 2SC - 2SC LSZH Yellow 5m	5	SM (G.652D)	SC
☎ N123.4CTY2	LANmark-OF Patch cord Singlemode OS2 2SC - 2ST LSZH Yellow 2m	2	SM (G.652D)	SC
☎ N123.4CTY5	LANmark-OF Patch cord Singlemode OS2 2SC - 2ST LSZH Yellow 5m	5	SM (G.652D)	SC
☎ N123.4TTY2	LANmark-OF Patch cord Singlemode OS2 2ST - 2ST LSZH Yellow 2m	2	SM (G.652D)	ST
☎ N123.4TTY5	LANmark-OF Patch cord Singlemode OS2 2ST - 2ST LSZH Yellow 5m	5	SM (G.652D)	ST
☎ N123.7LLO2	LANmark-OF Patchcord Multimode 50/125 OM4 2LC - 2LC LSZH Orange 2m	2	OM4 50/125	LC

☎ = Make to order, 📦 = Make to stock

Optical Performance Patch Cords

Fibre type	Connector	Polishing	Insertion loss max.	Return loss min.
Multimode	ST-SC-LC	PC	0,3 dB	> 30 dB
Multimode	MT-RJ	PC	0,3 dB	NA
Singlemode	ST-SC-LC	PC	0.3 dB	> 40 dB
Singlemode	SC-LC	APC	0,3 dB	> 55 dB
Singlemode	MT-RJ	NA	NA	NA

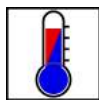

Operating temperature, range
-10 .. 50 °C



Fire retardant
IEC 60332-3 Cat.C



Minimum static operating bending radius
40 mm

Pigtails & Splicing Materials

LANmark-OF Splicing Accessories with Aluminium Protectors Preloaded Sliding Panel

Description

Family Characteristics

- Family of patch panel accessories for termination of a cable with fusion splicing techniques.
- Provides management for cable and pigtails within the fibre patch panel.
- The cassette protects the fusion splices and holds them in position.
- The splice cassette can retain up to 24 fusion splices.
- Four trays can be stacked inside the patch panels resulting in a maximum capacity of 96 fusion splices in a patch panel.
- Splice cassettes are fixed to each other at the back of the cassettes with the provided hinges. This feature facilitates the inspection after installation since the cassettes can be lifted and tilted.
- The larger cassettes facilitates 2 rings of routing: an inner ring for the fibres of the pigtails and an outer ring for the fibres of the cable.
- Splicing with Aluminium protectors can be used for loose tube cables, i.e. fibres with a 250 um coating. Aluminium protectors can not be used with tight buffer cables, i.e. fibres with a 900 um coating.
- Splicing with Aluminium protectors can be used for maxistrap pigtails.
- LANmark-OF Bend Limiting Tube (N890.145) can be used to split up fibres of loose tube cable into different splice cassettes.
- These splice cassettes can be installed in the LANmark-OF and LANsense-OF sliding preloaded patch panels (N439.2B* and N883.2B*).

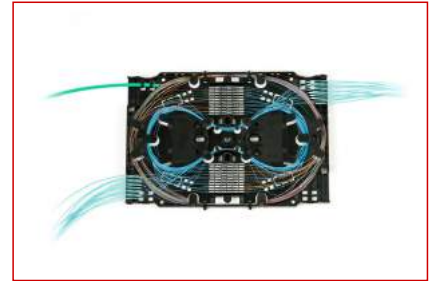

LANmark-OF

Standards

**International ISO11801:2002/
A1:2008**

LANmark-OF Splicing Accessories with Aluminium Protectors

N890.091: LANmark-OF Splice Cassette 24 Aluminium Protection Sliding Pre-loaded Panel

- Splice Cassette for management of splices with Aluminium protectors.
- Provides support for 2*12 splices with Aluminium protectors.
- Designed for use with loose tube cables (250 um coated fibres).
- Designed for use with maxistrrip pigtails.



N890.003: LANmark-OF Fusion Splice Aluminium Protectors

- LANmark OF- accessories to complete the splicing system with Aluminium protectors
- 150 pieces per bag
- Length: 30 mm
- Compatible with loose tube cables (250 um coated fibres)
- Compatible with maxistrrip pigtails
- Designed for Nexans' splice cassette for 24 Aluminium fusion splice protectors (N890.091)



N890.092: LANmark-OF Cover Splice Cassette Sliding Pre-loaded Panel

- LANmark-OF accessories to complete splice cassette system.
- LANmark-OF splice cassette cover compatible with N890.090 and N890.091.
- When the splice cassettes are stacked only the top splice cassette requires a cover.

LANmark-OF Splicing Accessories with Aluminium Protectors Preloaded Sliding Panel



N890.004: Tool for Aluminium Fusion Splice Protectors

- A crimp tool for easy installation of the Aluminium fusion splice protectors.
- Compatible with Nexans Aluminium fusion splice protector (N890.003).



LANmark-OF Splicing Accessories with Aluminium Protectors Snap-In Panel

Description

Family Characteristics

- Family of patch panel accessories for termination of a cable with fusion splicing techniques.
- Provides management for cable and pigtails within the fibre patch panel.
- The cassette protects the fusion splices and holds them in position.
- The splice cassette can retain up to 24 fusion splices.
- Four trays can be stacked inside the patch panels resulting in a maximum capacity of 96 fusion splices in a patch panel.
- Splicing with Aluminium protectors can be used for loose tube cables, i.e. fibres with a 250 um coating. Aluminium protectors can not be used with tight buffer cables, i.e. fibres with a 900 um coating.
- Splicing with Aluminium protectors can be used for maxistrap pigtails.
- LANmark-OF Bend Limiting Tube (N890.145) can be used to split up fibres of loose tube cable into different splice cassettes.
- These splice cassettes can be installed in the LANmark-OF Snap-In Patch Panel (N441.203 and N441.204) and the LANmark-OF Zone Distribution Box (N521.630).



LANmark-OF

Standards

International ISO11801:2002/
A1:2008

LANmark-OF Splicing Accessories with Aluminium Protectors

N890.096: LANmark-OF Splice Cassette 24 Aluminum Protectors Snap-In Panel

Snap-In Panel

- Splice Cassette for management of splices with Aluminium protectors.
- Provides support for 2*12 splices with Aluminium protectors.
- Designed for use with loose tube cables (250 um coated fibres).
- Designed for use with maxistrrip pigtails.



N890.003: LANmark-OF Fusion Splice Aluminium Protectors

- LANmark OF- accessories to complete the splicing system with Aluminium protectors
- 150 pieces per bag
- Length: 30 mm
- Compatible with loose tube cables (250 um coated fibres)
- Compatible with maxistrrip pigtails
- Designed for Nexans' splice cassette for 24 Aluminium fusion splice protectors (N890.096)



N890.097: Cover for Splice Cassette Snap-In Panel

- LANmark-OF accessories to complete splice cassette system.
- LANmark-OF splice cassette cover compatible with N890.095 and N890.096.

LANmark-OF Splicing Accessories with Aluminium Protectors Snap-In Panel

- When the splice cassettes are stacked only the top splice cassette requires a cover.



N890.004: Tool for Aluminium Fusion Splice Protectors

- A crimp tool for easy installation of the Aluminium fusion splice protectors.
- Compatible with Nexans Aluminium fusion splice protector (N890.003).



LANmark-OF Splicing Accessories with Heatshrink Protectors Preloaded Sliding Panel

Description

Family Characteristics

- Family of patch panel accessories for termination of a cable when using fusion splicing techniques.
- The cassette protects the fusion splices and holds them in position.
- The splice cassette can retain up to 12 fusion splices.
- Four trays can be stacked inside the patch panels resulting in a maximum capacity of 48 fusion splices in a patch panel.
- Splice cassettes are fixed to each other at the back of the cassettes with the provided hinges. This feature facilitates the inspection after installation since the cassettes can be lifted and tilted.
- The large cassettes facilitates 2 rings of routing: an inner ring for the fibres of the pigtails and an outer ring for the fibres of the cable.
- Splicing with heat shrink protectors can be used for both tight buffer and loose tube cables, i.e. heat shrink protectors are compatible with both 250 and 900 um coated fibres.
- Splicing with heat shrink protectors can be used for both maxistrap and tight buffer pigtails.
- LANmark-OF Bend Limiting Tube (N890.145) can be used to split up fibres of loose tube cable into different splice cassettes.
- These splice cassettes can be installed in the LANmark-OF and LANsense-OF sliding preloaded patch panels (N439.2B* and N883.2B*).

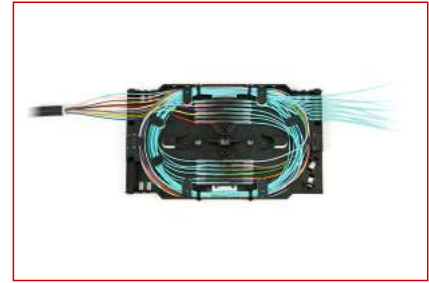

LANmark-OF

Standards

International ISO11801:2002/
A1:2008

LANmark-OF Splicing Accessories with Heatshrink Protectors

N890.090: LANmark-OF Splice Cassette 12 Heat Shrink Protection Sliding Preloaded Panel

- Splice cassette for management of splices with heat shrink protectors.
- Provides support for 2*6 heat shrink splice protectors.
- Designed for use with both loose tube and tight buffer cables, i.e. 250 and 900 um coated fibres.
- Designed for use with both maxistrip and tight buffer pigtails.



N890.021: LANmark-OF Fusion Splice Heat Shrink protectors (45mm)

- LANmark OF-accessories to complete the splicing system with heat shrink protectors
- 100 pieces per bag
- Length: 45mm
- Compatible with tight buffer or loose tube cables, i.e. 250 and 900 um coated fibres.
- Compatible with tight buffer and maxistrip pigtails
- Designed for Nexans' splice cassette for 12 heat shrink fusion splice protectors (N890.090)



N890.092: LANmark-OF Cover Splice Cassette Sliding Preloaded Panel

- LANmark-OF accessories to complete splice cassette system.
- LANmark-OF splice cassette cover compatible with N890.091 and N890.092.
- When the splice cassettes are stacked only the top splice cassette requires a cover.

LANmark-OF Splicing Accessories with Heatshrink Protectors Preloaded Sliding Panel



LANmark-OF Splicing Accessories with Heatshrink Protectors Snap-In Patch Panel

Description

Family Characteristics

- Family of patch panel accessories for termination of a cable when using fusion splicing techniques.
- The cassette protects the fusion splices and holds them in position.
- The splice cassette can retain up to 12 fusion splices.
- Four trays can be stacked inside the patch panels resulting in a maximum capacity of 48 fusion splices in a patch panel.
- Splicing with heat shrink protectors can be used for both tight buffer and loose tube cables, i.e. heat shrink protectors are compatible with both 250 and 900 um coated fibres.
- Splicing with heat shrink protectors can be used for both maxistrip and tight buffer pigtails.
- LANmark-OF Bend Limiting Tube (N890.145) can be used to split up fibres of loose tube cable into different splice cassettes.
- These splice cassettes can be installed in the LANmark-OF Snap-In Patch Panel (N441.203 and N441.204) and the LANmark-OF Zone Distribution Box (N521.630).



LANmark-OF

Standards

**International ISO11801:2002/
A1:2008**

LANmark-OF Splicing Accessories with Heatshrink Protectors

N890.095: LANmark-OF Splice Cassette 12 Heat Shrink Protectors Snap-In Panel **Snap-In Patch Panel**

- Splice cassette for management of splices with heat shrink protectors.
- Provides support for 2*6 heat shrink splice protectors.
- Designed for use with both loose tube and tight buffer cables, i.e. 250 and 900 um coated fibres.
- Designed for use with both maxistrip and tight buffer pigtails.



N890.021: LANmark-OF Fusion Splice Heat Shrink protectors (45mm)

- Lanmark OF-accessories to complete the splicing system with heat shrink protectors
- 100 pieces per bag
- Length: 45mm
- Compatible with tight buffer or loose tube cables, i.e. 250 and 900 um coated fibres.
- Compatible with tight buffer and maxistrip pigtails
- Designed for Nexans' splice cassette for 12 heat shrink fusion splice protectors (N890.095)



N890.097: Cover for Splice Cassette Snap-In Panel

- LANmark-OF accessories to complete splice cassette system.

LANmark-OF Splicing Accessories with Heatshrink Protectors Snap-In Patch Panel

- LANmark-OF splice cassette cover compatible with N890.095 and N890.096.
- When the splice cassettes are stacked only the top splice cassette requires a cover.



Contact

LAN Systems (Nexans Cabling Solutions)
Phone: +44 (0)1256 486640
ncs.uk@nexans.com

Splice Materials**Description**

A range of materials and accessories for splicing

**LANmark-OF****Standards**

International ISO/IEC 11801

Contact

LAN Systems (Nexans Cabling Solutions)
 Phone: +44 (0)1256 486640
 ncs.uk@nexans.com

Splice Materials

Product List

☎ = Make to order, 📦 = Make to stock

Nexans ref.	Name
📦 N890.145	LANmark-OF Bend Limiting Tube
📦 N890.024	LANmark-OF Fusion Splice Heat Shrink Protection (65mm)
📦 N890.023	Splice Holder
📦 N890.044	Splitter tube

☎ = Make to order, 📦 = Make to stock

LANmark-OF Pigtails Maxistrip

- Maxistrip pigtail for ease of splicing and high density
- Insertion loss per connection: 0.3 dB maximum
- Factory terminated fibre assembly
- 100 % factory tested
- Compatible with LANmark-OF splice cassette with heat shrink or Aluminium protection.

Description

Pigtail family characteristics

- Fibre assembly to terminate cable with fusion splicing
- Available with ST, SC, LC and MTRJ connectors
- Suitable for use in patch panels using splice cassettes.
- The pigtails can be stripped in one action over a long distance of up to 1m.
- Insertion loss: typical value is 0.1 dB, maximum value is 0.3 dB.

Fibre types

- Nexans LANmark-OF pigtails are available in all standardised optical fibre classes, multimode and singlemode.
- The MM50 version is designed to be used in a OM3 or a OM3xt compliant system and is backwards compliant with OM2 and OM2xt systems. The outer sheath for this type of pigtail is aqua.
- The MM62.5 version is designed for use in OM1 or OM1xt compliant systems. These pigtails are orange.
- The singlemode version is OS2 compliant with G652d fibre inside. These pigtails are yellow.
- The multimode versions can be used in laser optimised systems using the LANmark-OF xt cables.

Compatibility and installation practices

- Maxistrip pigtails are compatible with heat shrink splice cassettes (N890.095) with heat shrink protections (N890.021).
- Maxistrip pigtails are compatible with splice cassettes (N890.096) with Aluminium protections (N890.021).
- Maxistrip pigtails are recommended to be used with loose tube cables, i.e. with 250 um fibres. When using tight buffer cables (900 um fibres) additional stress on the maxistrip pigtails should be limited as much as possible
- For proper alignment in the fusion splice tool the pigtail is fixed on the 250 um coating after stripping the 900 um coating. Fixing the pigtail on the 900 um coating will lead to improper alignment.
- In addition the pigtail needs to be stripped till the cladding around the splice area before insertion in the splice tool.

Guarantees

Nexans LANmark-OF pigtails are covered by Nexans warranty as described in the General Terms and Conditions

**LANmark-OF**

Standards

International ISO/IEC 11801

LANmark-OF Pigtails Maxistrip

Optical performance pigtails

Fibre type	Connector	Polishing	Insertion loss max.	Return loss min.
Multimode	ST-SC-LC	PC	0,3 dB	> 30 dB
Multimode	MT-RJ	PC	0,3 dB	NA
Singlemode	ST-SC-LC	PC	0.3 dB	> 40 dB
Singlemode	SC-LC	APC	0,3 dB	> 55 dB
Singlemode	MT-RJ	NA	NA	NA

Pigtails maxistrip: available products

Fibre type	Connector	N-number	Description
SM	ST	N123.4MTY	LANmark-OF Pigtail ST Singlemode Maxistrip LSZH 9/125 1m Yellow
	SC	N123.4MCY	LANmark-OF Pigtail SC Singlemode Maxistrip LSZH 9/125 1m Yellow
	LC	N123.4MLY	LANmark-OF Pigtail LC Singlemode Maxistrip LSZH 9/125 1m Yellow
SM APC	SC	N120.4MDY	LANmark-OF Pigtail SC SM APC Maxistrip LSZH 9/125 1m Yellow
	LC	N120.4MPY	LANmark-OF Pigtail LC SM APC Maxistrip LSZH 9/125 1m Yellow
OM1	MTRJ	N123.0MMO	LANmark-OF Pigtail MTRJ OM1 Maxistrip LSZH 62.5/125 1m Orange
	ST	N123.0MTO	LANmark-OF Pigtail ST OM1 Maxistrip LSZH 62.5/125 1m Orange
	SC	N123.0MCO	LANmark-OF Pigtail SC OM1 Maxistrip LSZH 62.5/125 1m Orange
	LC	N123.0MLO	LANmark-OF Pigtail LC OM1 Maxistrip LSZH 62.5/125 1m Orange
OM3	MTRJ	N123.5MMA	LANmark-OF Pigtail MTRJ OM2/OM3 Maxistrip LSZH 50/125 1m Aqua
	ST	N123.5MTA	LANmark-OF Pigtail ST OM2/OM3 Maxistrip LSZH 50/125 1m Aqua
	SC	N123.5MCA	LANmark-OF Pigtail SC OM2/OM3 Maxistrip LSZH 50/125 1m Aqua
	LC	N123.5MLA	LANmark-OF Pigtail LC OM2/OM3 Maxistrip LSZH 50/125 1m Aqua
OM4	MTRJ	N123.7MMA	LANmark-OF Pigtail MTRJ OM4 Maxistrip LSZH 50/125 1m Aqua
	ST	N120.7MTA	LANmark-OF Pigtail ST OM4 Maxistrip LSZH 50/125 1m Aqua
	SC	N120.7MCA	LANmark-OF Pigtail SC OM4 Maxistrip LSZH 50/125 1m Aqua
	LC	N120.7MLA	LANmark-OF Pigtail LC OM4 Maxistrip LSZH 50/125 1m Aqua

LANmark-OF Pigtails Tight Buffer

- Tight buffer pigtail for ease of splicing
- Insertion loss per connection: 0.3 dB maximum
- Factory terminated fibre assembly
- 100 % factory tested
- Compatible with LANmark-OF splice cassette with heat shrink protection.

Description

Pigtail family characteristics

- Fibre assembly to terminate cable with fusion splicing
- Available with ST, SC, LC and MTRJ connectors
- Suitable for use in patch panels using splice cassettes.
- The pigtails can be stripped in one action over a distance of 1-2 cm.
- Insertion loss: typical value is 0.1 dB, maximum value is 0.3 dB.

Fibre types

- Nexans LANmark-OF pigtails are available in all standardised optical fibre classes, multimode and singlemode.
- The MM50 version is designed to be used in a OM3 or a OM3xt compliant system and is backwards compliant with OM2 and OM2xt systems. The outer sheath for this type of pigtail is aqua.
- The MM62.5 version is designed for use in OM1 or OM1xt compliant systems. These pigtails are orange.
- The singlemode version is OS2 compliant with G652d fibre inside. These pigtails are yellow.
- The multimode versions can be used in laser optimised systems using the LANmark-OF xt cables.

Compatibility and installation practices

- Tight buffer pigtails are compatible with heat shrink splice cassettes (N890.020) with heat shrink protections (N890.021).
- Tight buffer pigtails are recommended to be used with tight buffer cables, i.e. with 900 um fibres. When using loose tube cables (250 um fibres) additional stress on the loose tube fibres should be limited as much as possible
- Around the splice area the pigtail needs to be stripped till the cladding before insertion in the splice tool.
- For proper alignment in the fusion splice tool the pigtail is fixed on the 900 um outer sheath. There is no need to strip the outer sheath of the pigtail on the place for fixation for getting a proper fixation.

Guarantees

Nexans LANmark-OF pigtails are covered by Nexans warranty as described in the General Terms and Conditions

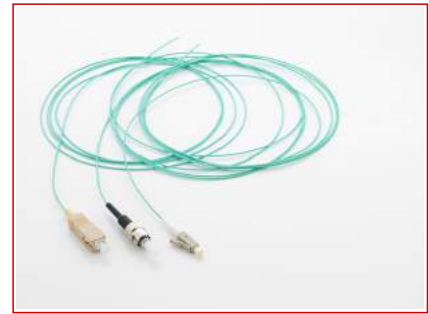
**LANmark-OF**

Standards

International ISO/IEC 11801

LANmark-OF Pigtails Tight Buffer

Optical performance pigtails

Fibre type	Connector	Polishing	Insertion loss max.	Return loss min.
Multimode	ST-SC-LC	PC	0,3 dB	> 30 dB
Multimode	MT-RJ	PC	0,3 dB	NA
Singlemode	ST-SC-LC	PC	0.3 dB	> 40 dB
Singlemode	SC-LC	APC	0,3 dB	> 55 dB
Singlemode	MT-RJ	NA	NA	NA

Pigtails tight buffer: available products

Fibre type	Connector	N-number	Description
SM	ST	N123.4TTY	LANmark-OF Pigtail ST SM Tight Buffer LSZH 9/125 1m Yellow
	SC	N123.4TCY	LANmark-OF Pigtail SC SM Tight Buffer LSZH 9/125 1m Yellow
	LC	N123.4TLY	LANmark-OF Pigtail LC SM Tight Buffer LSZH 9/125 1m Yellow
SM APC	SC	N120.4TDY	LANmark-OF Pigtail SC SM APC Tight Buffered LSZH 9/125 1m Yellow
	LC	N120.4TPY	LANmark-OF Pigtail LC SM APC Tight Buffered LSZH 9/125 1m Yellow
OM1	MTRJ	N123.0TMO	LANmark-OF Pigtail MTRJ OM1 Tight Buffer LSZH 62.5/125 1m Orange
	ST	N123.0TTO	LANmark-OF Pigtail ST OM1 Tight Buffer LSZH 62.5/125 1m Orange
	SC	N123.0TCO	LANmark-OF Pigtail SC OM1 Tight Buffer LSZH 62.5/125 1m Orange
	LC	N123.0TLO	LANmark-OF Pigtail LC OM1 Tight Buffer LSZH 62.5/125 1m Orange
OM3	MTRJ	N123.5TMA	LANmark-OF Pigtail MTRJ OM2/OM3 Tight Buffer LSZH 50/125 1m Aqua
	ST	N123.5TTA	LANmark-OF Pigtail ST OM2/OM3 Tight Buffer LSZH 50/125 1m Aqua
	SC	N123.5TCA	LANmark-OF Pigtail SC OM2/OM3 Tight Buffer LSZH 50/125 1m Aqua
	LC	N123.5TLA	LANmark-OF Pigtail LC OM2/OM3 Tight Buffer LSZH 50/125 1m Aqua
OM4	MTRJ	N120.7TMA	LANmark-OF Pigtail MTRJ OM4 Tight Buffer LSZH 50/125 1m Aqua
	ST	N120.7TTA	LANmark-OF Pigtail ST OM4 Tight Buffer LSZH 50/125 1m Aqua
	SC	N120.7TCA	LANmark-OF Pigtail SC OM4 Tight Buffer LSZH 50/125 1m Aqua
	LC	N120.7TLA	LANmark-OF Pigtail LC OM4 Tight Buffer LSZH 50/125 1m Aqua

Adaptors

LANmark-OF Snap-In Adapter

Description

Application

LANmark-OF Snap-In adapters have been designed for snapping into the modular OF patch panels and ZD boxes. They are available in single SC, dual SC, LC duplex and MT-RJ version. The 2 Small Form Factor connector types offer double density, as two fibre connections are offered on the SC-type footprint. Installation time is saved as the snap-in concept replaces the time-consuming screwing attachment of coupling devices.

Performance

LC and SC versions are available in Multimode and Singlemode, MT-RJ is only available in Multimode.

**LANmark-OF**

Standards

International ISO/IEC 11801

LANmark-OF Snap-In Adapter

Product List

☎ = Make to order, 📦 = Make to stock

Nexans ref.	Name	Connector type
☎ N205.611	LANmark-OF Snap-In Adapter 2LC-2LC Multimode	LC
☎ N205.621	LANmark-OF Snap-In Adapter 2LC-2LC Singlemode	LC
☎ N205.614	LANmark-OF Snap-In Adapter DSC-DSC Multimode	SC Duplex
☎ N205.624	LANmark-OF Snap-In Adapter DSC-DSC Singlemode	SC Duplex
☎ N205.612	LANmark-OF Snap-In Adapter MT-RJ - MT-RJ	MT-RJ
☎ N205.613	LANmark-OF Snap-In Adapter SC-SC Multimode	SC
☎ N205.623	LANmark-OF Snap-In Adapter SC-SC Singlemode	SC

☎ = Make to order, 📦 = Make to stock

Contact

LAN Systems (Nexans Cabling Solutions)
Phone: +44 (0)1256 486640
ncs.uk@nexans.com

Standard Adaptors

Description

Standard format adaptors and couplers



LANmark-OF

Standards

International ISO/IEC 11801

Standard Adaptors

Product List

☎ = Make to order, 📦 = Make to stock

Nexans ref.	Name
📦 N205.127	Dual SC coupler MM
📦 N205.158	Dual SC coupler SM
📦 N205.135	LANmark-OF MTRJ adapter Multimode
📦 N205.131	LANmark-OF Quad LC Multimode adaptor
📦 N205.133	LANmark-OF Quad LC Singlemode adaptor
📦 N205.153	LANmark-OF Singlemode adaptor ST-ST
📦 N205.123	LANmark-OF adaptor Multimode ST-ST

☎ = Make to order, 📦 = Make to stock

Tools & Accessories

LANmark-OF Cleaning Tools

- Cleaning tools for cleaning fibre connector and adaptors
- Cleaning tools for single connectors:SC,ST and LC
- Cleaning tools for male and female array connectors

Description

Cleaning of fibre connectors and adaptors is extremely important to achieve optimal optical performance and low loss connectivity. The Nexans' cleaning tools allow cleaning unmated connectors and can also clean connectors that are installed in a patch panel. The cassette MPO cleaner allows cleaning effectively unmated male MPO connectors.



Product List

Nexans ref.	Name
☐ N890.122	LANmark-OF LC Cleaning Tool
☐ N890.125	LANmark-OF MPO Cassette Cleaning Tool
☐ N890.120	LANmark-OF MPO Cleaning Tool
☐ N890.121	LANmark-OF SC/ST Cleaning Tool

☎ = Make to order, ☐ = Make to stock

LANmark-OF Fibre Accessories

- OF-LANmark accessories to complete the whole system.
- OF splice trays
- SC & ST connectors
- SC & ST couplers
- Fusion splice protection & Tool
- Cable gland & splitter tube
- Micro tube

Description

Application

- Optical fibre accessories to complete all Nexans OF products, patch panels, ZD boxes, splitter box.
- Designed for the installation of zone wiring, fibre to the office, fibre to the desk and backbone connections.

Compatibility

Suitable for tight buffer cable (direct termination) or loose tube using splice tray and pigtails

Compatible with all Nexans ST or SC patch panels, zone distribution boxes and splice box

Installation

- The ST and SC connectors are in both versions hot melt or epoxy field installable for easy installing.
- The single ST and dual SC couplers are available in single mode and mono mode to complete all OF structural hardware.
- The splice trays are easy to fix in all Nexans OF patch panels, OF ZD boxes and can distribute 12 optical fibres.
- Cable glands can be useful for entering cables or distributing fibres in to the OF patch panels and OF ZD boxes.
- Aluminium fusion splice protection protect the spliced fibres and are easily manageable in the splice tray.
- A tool is offered for easy installing the aluminium fusion splice protection.
- Splitter tube aloud to split up your cable into different patch panels.
- A blind plate completes the e-ssential patch panel when used as splice patch panel.
- Micro tubes of 0.9mm can be used to install a hot melt connector on a loose tube fibre.



LANmark-OF

Standards

International ISO/IEC 11801

LANmark-OF Fibre Accessories

Product List

☎ = Make to order, 📦 = Make to stock

Nexans ref.	Name
📦 N890.043	Cable gland for splitter tube
📦 N441.132	Essential-OF Blind face plate (For splitter)
📦 N890.147	LANmark-OF Cable gland 20mm
📦 N890.146	LANmark-OF Cable gland 25mm
📦 N890.045	Microtube 0.9 mm

☎ = Make to order, 📦 = Make to stock

Intelligent Infrastructure Management

LANsense is Nexans Intelligent Infrastructure Management (IIM) solution. It is an internet enabled hardware and software package which can automatically discover and monitor network connectivity in real-time, to ensure network connections are secure and that connectivity documentation is always 100% accurate. LANSense is vendor independent and can be retro-fitted to existing systems.

Benefits:

- Increased Security
- Cost effective change control and management
- Reduced downtime
- Asset Management
- Remote site monitoring
- the ability to integrate, control, and manage building management services (Access Control, intruder systems, CCTV, HVAC etc)

Nexans work in partnership with iTRACS, the leaders in IIM software, and offer two levels of software:

- LANSense Enterprise - the full featured version requiring specialist configuration
- LANSense - a pre-configured solution but with limited options for customisation.

These software solutions can be configured with different hardware products to deliver specialist solutions for Data Centres, Enterprise, or SME customers with branch networks.

For more information on becoming a Nexans Certified LANSense Partner please contact us at ncs.uk@nexans.com



Software

Choice of software functionality

Description

LANsense is Nexans Intelligent Infrastructure Management (IIM) solution. It is an internet enabled hardware and software package which can automatically discover and monitor network connectivity in real-time, to ensure network connections are secure and that connectivity documentation is always 100% accurate. LANsense is vendor independent and can be retro-fitted to existing systems.

Benefits:

- Increased Security
- Cost effective change control and management
- Reduced downtime
- Asset Management
- Remote site monitoring
- the ability to integrate, control, and manage building management services (Access Control, intruder systems, CCTV, HVAC etc)

Nexans work in partnership with iTRACS, the leaders in IIM software, and offer three levels of software:

- LANsense
- LANsense Enterprise Edition
- LANsense Data Centre Edition

These software solutions can be configured with different hardware products to deliver specialist solutions for Data Centres, Enterprise, or SME customers with branch networks.

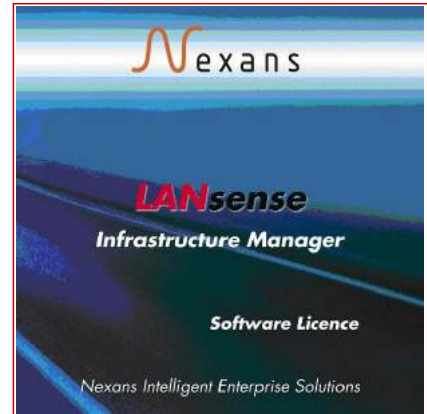

LANsense™

Standards

International ISO/IEC 11801

LANsense EMAC

EMAC Products

Description

Corporate data centres are well known as significant power users, with a large sized data centre consuming similar amounts of power to an average sized town. As data centres today generate more heat output and often suffer from inadequate cooling, the need to operate efficiently and cost effectively against infrastructure and power constraints is increasing.

Obviously the greater capacity required, the greater impact on ensuring continuity of supply. Add to this, the escalating cost of energy, and the requirement for management information and control becomes evermore critical.

Nexans provides a range of standard intelligent power management capabilities, for both new and existing builds specified for both power monitoring only, or a combination of power monitoring with individual outlet control.

Defined upper and lower thresholds allow the client to differentiate between warning and critical status, generating various alarms and alerts, with appropriate escalation paths.

Aggregation of configuration information across data centre equipment, for intelligent monitoring and alarm processing, provides 'real time' identification of changes, scheduled polling and the ability to capture detailed data to produce highly sophisticated and graphical management information reports, enabling clients to perform trend analysis and risk management for mission critical services.

Status information can be gathered either locally or remotely via secure authenticated IP access (LDAP) monitoring RMS volts, amps, kVA, kWh, power factor and frequency.

Detailed values and management information across device location, power and cooling, network connectivity, asset application and customer information enable us to present analysis on current and historical trending. This trend analysis can be further utilised to help CIOs make informed decisions on capacity planning, risk analysis, performance benchmarking and policing service level agreements.

To optimise both power consumption and energy use, our intelligent offerings make it possible to meter actual power usage and produce trend data for any single or group of physical systems, enabling:

- Adequate capacity for existing & future needs
- Monitoring, measuring & reporting of power usage via multiple clients
- Billing stream capability for hosted clients
- Prevention of unauthorised use of power outlets / equipment deployment
- System load management (phase balancing, capacity planning etc)
- Recovery of locked servers via remote IP power cycling
- Alarming & trending of system, rack, powerstrip and outlet level overload conditions.

**LANsense™**

Standards

International Nexans specificationRoHS conform
Yes

LANsense EMAC

Characteristics

Usage characteristics

RoHS conform

Yes



RoHS

RoHS conform
Yes

LANsense EMAC

Product List

☎ = Make to order, 📦 = Make to stock

Nexans ref.	Name
📦 N878.21220	LANsense Dual Supply Link Box 32A
📦 N878.32001	LANsense Humidity Sensor 2m
📦 N878.32002 Nouveauté	LANsense Humidity Sensor RJ45
📦 N878.41004 Nouveauté	LANsense Magnetic Door Sensor RJ45 4m
📦 N878.41001	LANsense Microswitch Door Sensor 4m
📦 N878.41003 Nouveauté	LANsense Microswitch Door Sensor RJ45 2m
📦 N878.NIPM Nouveauté	LANsense Non-Invasive Power Monitor
📦 N878.22110	LANsense PDU 32A 12x10A IEC C13 Horizontal
📦 N878.24210	LANsense PDU 32A 16x10A IEC C13 Monitor and Control
📦 N878.22210	LANsense PDU 32A 16x10A IEC C13 Vertical
📦 N878.22215	LANsense PDU 32A 24x10A IEC C13 Vertical
📦 N878.11002 Nouveauté	LANsense Rack Manager II 6 Channel Autosensing
📦 N878.11003 Nouveauté	LANsense Row Controller 12 Channel Autosensing
📦 N878.11004 Nouveauté	LANsense Row Controller Expansion Module
📦 N878.31001	LANsense Temperature Sensor 2m
📦 N878.31002 Nouveauté	LANsense Temperature Sensor RJ45 2m

☎ = Make to order, 📦 = Make to stock

Contact

LAN Systems (Nexans Cabling Solutions)
Phone: +44 (0)1256 486640
ncs.uk@nexans.com

LANsense Cu panel

- LANsense IIM compatible
- Empty for use with modular connectors sold separately

Description

LANsense copper patch panels carry on-board intelligence which remains dormant until enabled by LANsense analysers and software. The panels have in-built sensors to detect the connection status of each port and an I/O connector to link to the analysers.

Manufactured from steel, the panel provides a robust, high density mounting mechanism for Nexans modular connectors.



LANsense™

Standards

International ISO/IEC 11801

LANsense Cu panel



Characteristics

















Usage characteristics



I/O Connector - Panel

Type 2

Product List

 = Make to order,  = Make to stock

Nexans ref.	Name
 N881.011	LANsense 24 Way Patch Panel for 808 connectors
 N881.051 Nouveauté	LANsense 24 Way Patch Panel for 808 connectors
 195513-1001 Remplacé	LANsense 24 Way Patch Panel for 808 connectors (ITT branded)
 N881.671 Nouveauté	LANsense Angled Panel 24 Snap-In Black
 N881.681 Remplacé	LANsense Angled Panel 24 Snap-In GG45 Black
 N881.685 Remplacé	LANsense Angled Panel 24 Snap-In GG45 White
 N881.675 Nouveauté	LANsense Angled Panel 24 Snap-In White
 N881.411 Nouveauté	LANsense Empty Sliding Patch Panel for 24 Snap-In connectors, Black
 N881.311 Nouveauté	LANsense Panel 24 Snap-In Black
 N881.111 Remplacé	LANsense Panel 24 Snap-In GG45 Black
 N881.151 Remplacé	LANsense Upgrade Frontplate for Fixed Modular Panel 24 GG45-type snap-in connectors, Black
 N881.351 Nouveauté	LANsense Upgrade Frontplate for Fixed Modular Panel 24 Snap-In connectors, Black
 N881.251 Remplacé	LANsense Upgrade Frontplate for Sliding Modular Panel 24 GG45-type snap-in connectors, Black
 N881.255 Remplacé	LANsense Upgrade Frontplate for Sliding Modular Panel 24 GG45-type snap-in connectors, White
 N881.451 Nouveauté	LANsense Upgrade Frontplate for Sliding Modular Panel 24 Snap-In connectors, Black
 N881.455 Nouveauté	LANsense Upgrade Frontplate for Sliding Modular Panel 24 Snap-In connectors, White
 N881.061 Nouveauté	LANsense Upgrade for 24 port 808 Modular Panel

 = Make to order,  = Make to stock

Contact

LAN Systems (Nexans Cabling Solutions)
Phone: +44 (0)1256 486640
ncs.uk@nexans.com

Cu Patch Cords

- 9th pin for port detection
- Ensures maximum channel performance
- Cat 5e & Cat 6 & Cat 6A/10G
- Screened & Unscreened
- Available in different lengths

Description

The Nexans LANsense patchcord range is suitable for use in voice or data network installations. The 4 pair construction and robust RJ45 connectors provide for long term network reliability. The patchcords have an unobtrusive external probe built into the plug boot which mates with the sensors built into the patch panels. The patchcords can be supplied in different lengths and with different colour latch protectors to allow differentiation of services and workgroups.



LANmark-6A

Standards

International EN 50265-2-1; ISO/
IEC 11801

National TIA/EIA-568-B.2

Cu Patch Cords

Product List

☎ = Make to order, 📦 = Make to stock

Nexans ref.	Name	Category	Length (m)	Screen
☎ LDWPCS010L0U10	LANsense 5e FTP PVC P/Cord 1m	Cat. 5e	1	FTP
📦 LDWPCS020L0U10	LANsense 5e FTP PVC P/Cord 2m	Cat. 5e	2	FTP
📦 LDWPCS030L0U10	LANsense 5e FTP PVC P/Cord 3m	Cat. 5e	3	FTP
📦 LDWPCS050L0U10	LANsense 5e FTP PVC P/Cord 5m	Cat. 5e	5	FTP
☎ LDWPCU010L0U10	LANsense 5e UTP PVC P/Cord 1m	Cat. 5e	1	UTP
☎ LDWPCU020L0U10	LANsense 5e UTP PVC P/Cord 2m	Cat. 5e	2	UTP
☎ LDWPCU030L0U10	LANsense 5e UTP PVC P/Cord 3m	Cat. 5e	3	UTP
☎ LDWPCU050L0U10	LANsense 5e UTP PVC P/Cord 5m	Cat. 5e	5	UTP
📦 LEWPCS010L0U10	LANsense 6 FTP PVC P/Cord 1m	Cat. 6	1	FTP
📦 LEWPCS020L0U10	LANsense 6 FTP PVC P/Cord 2m	Cat. 6	2	FTP
📦 LEWPCS030L0U10	LANsense 6 FTP PVC P/Cord 3m	Cat. 6	3	FTP
📦 LEWPCS050L0U10	LANsense 6 FTP PVC P/Cord 5m	Cat. 6	5	FTP
📦 195600-5010-3	LANsense 6 UTP PVC P/Cord 1m	Cat. 6	1	UTP
📦 195600-5020-3	LANsense 6 UTP PVC P/Cord 2m	Cat. 6	2	UTP
📦 195600-5030-3	LANsense 6 UTP PVC P/Cord 3m	Cat. 6	3	UTP
📦 195600-5050-3	LANsense 6 UTP PVC P/Cord 5m	Cat. 6	5	UTP
📦 N88A.P1F015OK Nouveauté	LANsense Patch Cord Cat 6A LSZH Screened 1.5m Orange	Cat. 6a	1.5	FTP
📦 N88A.P1F010OK Nouveauté	LANsense Patch Cord Cat 6A LSZH Screened 1m Orange	Cat. 6a	1	FTP
📦 N88A.P1F020OK Nouveauté	LANsense Patch Cord Cat 6A LSZH Screened 2m Orange	Cat. 6a	2	FTP
📦 N88A.P1F030OK Nouveauté	LANsense Patch Cord Cat 6A LSZH Screened 3m Orange	Cat. 6a	3	FTP
📦 N88A.P1F050OK Nouveauté	LANsense Patch Cord Cat 6A LSZH Screened 5m Orange	Cat. 6a	5	FTP

☎ = Make to order, 📦 = Make to stock

Contact

LAN Systems (Nexans Cabling Solutions)
Phone: +44 (0)1256 486640
ncs.uk@nexans.com

Fibre Panels

- LANSense IIM compatible
- 24, 48 or 96 fibre in 1HU versions
- Available for LC and SC connectors

Description

The LANSense range of patch panels provide a high density transition between building cables and active equipment.

Very high density versions are available with up to 96 fibre (48 ports) with LC for data centre environments.

Standard 24 or 48 fibre version with SC connections are also available.

A variety of cable entry holes are located at the rear of the panels to allow a wide range of cable variants to be accommodated. Cable entry hole blanks and fibre management are included with the panel. A complementary range of cable glands, that are supplied separately, ensure that cables are secured and enter the panel in a controlled manner. A simple to remove lid gives easy access to the panel interior.



LANSense™

Standards

International ISO/IEC 11801

Fibre Panels

Product List

☎ = Make to order, 📦 = Make to stock

Nexans ref.	Name	Connector type	I/O Connector - Panel
N883.131 ☎ Jusqu'à épuisement du stock	LANsense 24 SC Singlemode Patch Panel	SC	Type 1
📦 N883.221 Nouveauté	LANsense 48 Fibre LC Multimode Patch Panel	LC	Type 2
☎ N883.261 Nouveauté	LANsense 48 LC Multimode Patch Panel Black	LC	Type 2
☎ N883.133 Nouveauté	LANsense 48 SC Singlemode Patch Panel	SC	Type 2
☎ N883.223 Nouveauté	LANsense 96 LC Multimode Patch Panel	LC	Type 2
☎ N883.233 Nouveauté	LANsense 96 LC Singlemode Patch Panel	LC	Type 2
📦 N883.182 Nouveauté	LANsense Fibre Panel 24 SC Multimode Black	SC	Type 2
☎ N883.181 Nouveauté	LANsense Fibre Panel 24 SC Singlemode Black	SC	Type 2
☎ N883.2B48LCMM Nouveauté	LANsense Pre-Loaded Patch Panel 48 LC Multimode Sliding Black	SC	Type 1
☎ N883.2B48LCSM Nouveauté	LANsense Pre-Loaded Patch Panel 48 LC Singlemode Sliding Black	SC	Type 2

☎ = Make to order, 📦 = Make to stock

Contact

LAN Systems (Nexans Cabling Solutions)
Phone: +44 (0)1256 486640
ncs.uk@nexans.com

Fibre patchcords

- Additional copper pin for port detection
- High bandwidth OM3 fibre
- Available with LC, MTRJ, or SC connectors

Description

The MTRJ, SC and LC LANSense patch cord uses the standard MTRJ, SC and LC duplex connector, enabling high-density fiber connections to be achieved. The MTRJ, SC and LC LANSense cord however has an over-boot to incorporate the sensing capability of the LANSense products. The LANSense patch cords are available in both high bandwidth OM3 and single-mode OS2 fibre types and so offer a comprehensive range of patch cords for interfacing with the latest network equipment.



LANSense™

Standards

International ISO/IEC 11801

Fibre patchcords

Product List

☎ = Make to order, 📦 = Make to stock

Nexans ref.	Name	Length (m)	Connector type
📦 N884.5LLP1	LC Duplex LANsense P/Cord 50/125 OM3 - 1m	1	LC
📦 N884.5LLP2	LC Duplex LANsense P/Cord 50/125 OM3 - 2m	2	LC
📦 N884.5LLP3	LC Duplex LANsense P/Cord 50/125 OM3 - 3m	3	LC
📦 N884.5LLP5	LC Duplex LANsense P/Cord 50/125 OM3 - 5m	5	LC
📦 N884.4LLY1	LC Duplex LANsense P/Cord 9/125 OS1 - 1m	1	LC
📦 N884.4LLY2	LC Duplex LANsense P/Cord 9/125 OS1 - 2m	1	LC
☎ N884.5MMP1 Jusqu'à épuisement du stock	MT-RJ Duplex LANsense P/Cord 50/125 OM3 - 1m	1	MT-RJ
☎ N884.5MMP2 Jusqu'à épuisement du stock	MT-RJ Duplex LANsense P/Cord 50/125 OM3 - 2m	2	MT-RJ
☎ N884.5MMP3 Jusqu'à épuisement du stock	MT-RJ Duplex LANsense P/Cord 50/125 OM3 - 3m	3	MT-RJ
☎ N884.5MMP5 Jusqu'à épuisement du stock	MT-RJ Duplex LANsense P/Cord 50/125 OM3 - 5m	5	MT-RJ
📦 N884.5CCP1	SC Duplex LANsense P/Cord 50/125 OM3 - 1m	1	SC
📦 N884.5CCP2	SC Duplex LANsense P/Cord 50/125 OM3 - 2m	2	SC
📦 N884.5CCP3	SC Duplex LANsense P/Cord 50/125 OM3 - 3m	3	SC
📦 N884.5CCP5	SC Duplex LANsense P/Cord 50/125 OM3 - 5m	5	SC
📦 N884.4CCY1	SC Duplex LANsense P/Cord 9/125 OS2 - 1m	1	SC
📦 N884.4CCY2	SC Duplex LANsense P/Cord 9/125 OS2 - 2m	2	SC
📦 N884.4CCY3	SC Duplex LANsense P/Cord 9/125 OS2 - 3m	3	SC
📦 N884.4CCY5	SC Duplex LANsense P/Cord 9/125 OS2 - 5m	5	SC

☎ = Make to order, 📦 = Make to stock

Contact

LAN Systems (Nexans Cabling Solutions)
Phone: +44 (0)1256 486640
ncs.uk@nexans.com

LANsense Analysers

- 1U version up to 256 ports
- 6U version from 512 to 2048 ports
- Master and Link variants enabling upto 20480 ports per IP address
- Virtually unlimited scalability

Description

A LANsense analyser is required to monitor all network ports, record changes in the events log, and continuously update and maintain the connectivity database. It connects to the equipment presentation panel or integration strip and the horizontal distribution panel using I/O cables, and is in turn connected to the LANsense cable management SQL database.

It should be noted that 2 analyser ports (one for the horizontal connection and one for the system connection) are required for each user channel to be monitored.

Master and Link analysers can be connected to form a star wired network capable of monitoring up to 20480 ports in a "patch zone" using a single IP address. Multiple patch zones can be connected to a single database providing almost unlimited scalability.



LANsense™

Standards

International UL and CSA approval

LANsense Analysers

Product List

☎ = Make to order, 📦 = Make to stock

Nexans ref.	Name	I/O Connector - Analyser
☎ LXWANLL0101 Remplacé	LANsense 1U Link Analyser	Type A
☎ LXWANLM0101 Remplacé	LANsense 1U Master Analyser	Type A
☎ LXWANLS0101 Remplacé	LANsense 1U Standalone Analyser	Type A
☎ 195560-0603 Remplacé	LANsense 6U Link Analyser	Type A
☎ 195560-0602 Remplacé	LANsense 6U Master Analyser	Type A
☎ 195560-0601 Remplacé	LANsense 6U Standalone Analyser	Type A
☎ N870.1UL Nouveauté	LANsense Analyser 1U Link - MarkII	Type B
☎ N870.1UM Nouveauté	LANsense Analyser 1U Master - MarkII	Type B
☎ N870.6UL Nouveauté	LANsense Analyser 6U Link - MarkII	Type B
☎ N870.6UM Nouveauté	LANsense Analyser 6U Master - MarkII	Type B

☎ = Make to order, 📦 = Make to stock

- Next Generation Analyser
- Seperate analyser and display functions
- Increased density
- Supports additional functionality
- Simplified and more flexible system design

Description

The Next Generation Analyser is an exciting new development which opens up many possibilities for efficient analyser network design and advanced functionality to support the LANsense platform

Key features

- System Master Card (SMC) running Linux OS
- Self diagnostic test and health status
- No Cooling required
- Detects up to 8 connections on a single port
- 9th wire electrostatic protection
- Analyzer Card (AC) hot swap support
- Automated firmware distribution/installation
- Configuration by any Windows XP device
- Multiple deployment options
- Software control of Smart Patch Panel (SPP) interfaces
- "Plug and Play" deployment









**LANsense™**

Standards

International ISO/IEC 11801

Product List

☎ = Make to order, 📦 = Make to stock

Nexans ref.	Name
 N870.PSU2 Nouveauté	LANsense NGA 2 Amp Power Supply Unit
 N870.3UC Nouveauté	LANsense NGA 3U Card Cage
 N870.3UL Nouveauté	LANsense NGA 3U Card Cage Link Cover
 N870.3UM Nouveauté	LANsense NGA 3U Card Cage Master Cover
 N870.PSU7 Nouveauté	LANsense NGA 7 Amp Power Supply Unit
 N870.ACC Nouveauté	LANsense NGA Analyser Card
 N870.SPP Nouveauté	LANsense NGA HMI Panel 1U
 N870.SMC Nouveauté	LANsense NGA System Master Card
 N870.UPP Nouveauté	LANsense NGA USB Interface Adaptor

☎ = Make to order, 📦 = Make to stock

LANsense I/O and Master/Link cables

- I/O cables for analyser to panel connection
- Master/Link for Master analyser to Link analyser connection

Description

LANsense accessory cables are divided into two sub families:

Master / Link cables are used to interconnect Master and Link and analysers to form a star wired analyser network capable of monitoring a patch zone of up to 20480 ports. Multiple patch zones can exist within a LANsense database

I/O cords are used to connect LANsense patch panels or integration strips to the analysers. The 12 way adaptor and 3 x 8 Way splitter are used to maximise the usage of analyser ports within an installation.



LANsense™

Standards

International ISO/IEC 11801

LANsense I/O and Master/Link cables

Product List

☎ = Make to order, 📦 = Make to stock

Nexans ref.	Name	I/O Connector - Analyser	I/O Connector - Panel	Mat length (m)
📦 LXWCCL160XOO	Analyser M/L Cord 16.0m	N/A	N/A	16
📦 LXWCCL030XOO	Analyser M/L Cord 3.0m	N/A	N/A	3
📦 LXWCCL040XOO	Analyser M/L Cord 4.0m	N/A	N/A	4
📦 LXWCCL080XOO	Analyser M/L Cord 8.0m	N/A	N/A	8
📦 196102-0019	I/O Cord 24 way - 1.9m	Type A	Type 2	1.9
📦 LXWCCP021A20	I/O Cord 24 way - 2.1m	Type A	Type 1	2.1
📦 196102-0028	I/O Cord 24 way - 2.8m	Type A	Type 2	2.8
📦 LXWCCP030A20	I/O Cord 24 way - 3.0m	Type A	Type 1	3
📦 196102-0040	I/O Cord 24 way - 4.0m	Type A	Type 2	4
📦 LXWCCP043A20	I/O Cord 24 way - 4.3m	Type A	Type 1	4.3
📦 N871.CIO0010 Nouveauté	LANsense I/O Cable PVC Type C Rev 2 10m	Type C	Type 2	10
📦 N871.CIO003 Nouveauté	LANsense I/O Cable PVC Type C Rev 2 3m	Type C	Type 2	3
📦 N871.CIO005 Nouveauté	LANsense I/O Cable PVC Type C Rev 2 5m	Type C	Type 2	5
📦 N871.NIOH0010	Mark II I/O Cable 24 way - 1.0m	Type B	Type 2	1
📦 N871.NIOH0100	Mark II I/O Cable 24 way - 10.0m	Type B	Type 2	10
📦 N871.NIOH0020	Mark II I/O Cable 24 way - 2.0m	Type B	Type 2	2
📦 N871.NIOH0050	Mark II I/O Cable 24 way - 5.0m	Type B	Type 2	5
📦 N871.NIOHA2X12	Mark II I/O Cable Adaptor 12 way - 150mm	Type B	N/A	0.2
📦 N871.NIOH0102	Mark II I/O Cable Splitter 3 x 8 way - 350mm	Type B	N/A	0.4

☎ = Make to order, 📦 = Make to stock

LANsense Integration Strips

- LANSense IIM compatible
- Integration Strips designed for specific equipment

Description

LANSense Integration Strips are used to provide LANSense port detection functionality on non LANSense enabled products like switches in an interconnect environment.

They are used instead of a system side or port replication panel (used in a cross-connect environment) and allow LANSense cords to be connected directly into active equipment.

Integration strips are usually provided to fit 24 port devices but other port counts can be accommodated.

In order to create an Integration Strip a template is used to accurately communicate the dimensions and port layout of the device.

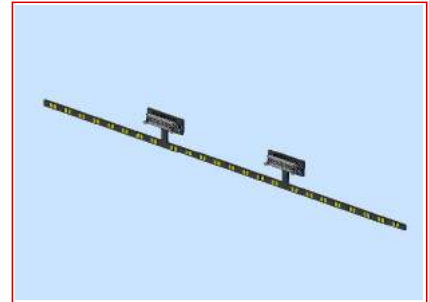

LANSense™

Standards

International Nexans specification

Industrial LAN & Harsh Environments

Contact

LAN Systems (Nexans Cabling Solutions)
Phone: +44 (0)1256 486640
ncs.uk@nexans.com

LANmark Industry Copper cables

Description

Copper cables for LANs in industrial and exposed areas.





LANmark
Industry



Standards

International ISO/IEC 11801; ISO/
IEC 24702

LANmark Industry Copper cables

Product List

Nexans ref.	Name
 N10i.002	LANmark Industry S/FTP AWG23 PUR black 500m reel
 N10i.004	LANmark Industry SF/UTP AWG24 LSZH+PE black 500m reel

 = Make to order,  = Make to stock

Contact

LAN Systems (Nexans Cabling Solutions)
Phone: +44 (0)1256 486640
ncs.uk@nexans.com

LANmark Industry Optical Fibre cables

Description

Fibre optic cables for LANs in industrial and exposed areas.



LANmark
Industry



Standards

International ISO/IEC 11801; ISO/
IEC 24702

LANmark Industry Optical Fibre cables

Product List

Nexans ref.	Name
 N165.922	LANmark Industry TBX 6x multimode 50/125 OM3 PUR black

 = Make to order,  = Make to stock

Contact

LAN Systems (Nexans Cabling Solutions)
Phone: +44 (0)1256 486640
ncs.uk@nexans.com

LANmark Industry DIN-Rail Outlets and boxes

Description

DIN-Rail mount Outlets and boxes for LANs in industrial and exposed areas.



LANmark
Industry

Standards

International ISO/IEC 11801; ISO/
IEC 24702

Contact

LAN Systems (Nexans Cabling Solutions)
Phone: +44 (0)1256 486640
ncs.uk@nexans.com

LANmark Industry IP65/67 outlets

LANmark Industry IP67 outlets

Description

IP65/67 outlet for LANs in industrial and exposed areas.





LANmark
Industry



Standards

International ISO/IEC 11801; ISO/
IEC 24702

LANmark Industry IP65/67 outlets

Product List

Nexans ref.	Name
 N42i.001	LANmark Industry IP65/67 outlet kit 2 Snap-In Category 6 black
 N42i.002	LANmark Industry IP65/67 outlet kit 2 Snap-In Category 6A black

 = Make to order,  = Make to stock

Contact

LAN Systems (Nexans Cabling Solutions)
Phone: +44 (0)1256 486640
ncs.uk@nexans.com

LANmark Industry patch cord RJ45 IP67/IP20 Cat.6

Description

Patchcords IP67/IP20 for LANs in industrial and exposed areas.



LANmark
Industry

Standards

International ISO/IEC 11801; ISO/
IEC 24702

LANmark Industry patch cord RJ45 IP67/IP20 Cat.6

Product List

☎ = Make to order, 📦 = Make to stock

Nexans ref.	Name
📦 N10i.E34DJ	LANmark Industry patch cord RJ45 IP67 Single-end Category 6 screened PVC 10m Yellow
📦 N10i.E34DJ	LANmark Industry patch cord RJ45 IP67/IP20 Category 6 screened PVC 1.5m Yellow
📦 N10i.E34OJ	LANmark Industry patch cord RJ45 IP67/IP20 Category 6 screened PVC 10m Yellow
📦 N10i.E34FJ	LANmark Industry patch cord RJ45 IP67/IP20 Category 6 screened PVC 3m Yellow
📦 N10i.E34HJ	LANmark Industry patch cord RJ45 IP67/IP20 Category 6 screened PVC 5m Yellow

☎ = Make to order, 📦 = Make to stock

General Accessories & Cabinets

Nexans have a complete range of accessories and hardware to complete the LAN system



Datacenter racks and frames

- 19-Inch mounting equipment for high-density cross-connect
- Ideal in Datacenters
- Designed to host both Copper and Fibre cabling
- Robust metal construction
- Enhanced access and cord management

Description

Application

LANmark High-Density racks and frames have been designed to host busy Cross-Connects in datacenters. Specific attention has been given to technical constraints of datacenters such as cooling and space scarcity. Numerous features contribute to an optimal space utilisation and enable installation on busy datacenter floors. These High-Density racks and frames enable excellent front, rear and lateral access. This is of great importance during installation but also during maintenance and upgrade operations. Proper management of large numbers of cords and securing clarity is critical for datacenters management and reliability over the life time. Examples of equipment that can be hosted in LANmark High-Density rack and frames are given below:

- Angled panels and accessories
- High Density Fibre optic panels
- MPO panels
- LANsense - Intelligent patching
- Suitable for Cat.6A, 7 and 7A
- Suitable for OM3, OM4 and OS2
- future Cat 6A and Class EA applications
- EMAC - Environmental control

Performance

LANmark High-Density racks and frames have been designed to host all LANmark fibre optic and copper products.

Installation

Nexans LANmark-6 feature accessories and bracket enabling the installation in various configuration and location of a datacenter. please see the datasheet of the main products for details.

Guarantees



Nexans LANmark High-Density Rack and Frames are covered by a parts and labour warranty as described in the Nexans Certified System Warranty.

Standards

International ISO/IEC 11801:2002/A2:2008

Datacenter racks and frames

Product List

Nexans ref.	Name
 N345.000 Nouveauté	LANmark High-Density Cross-Connect Cabinet 42U - Basic
 N345.012 Nouveauté	LANmark High-Density Cross-Connect Cabinet 42U - incl. Doors and Lateral Panels
 N345.400 Nouveauté	LANmark Overhead Patching Frame 4U

☎ = Make to order, 📦 = Make to stock

Selling delivery information

Delivery info: Datacenter racks and frames

Patch Guides, Blank Panels & Cable Management

- Patch guides to manage and store all patch cords.
- 1 HU and 2 HU for high density.
- 1 HU with rings for easy access.
- Cable guide for all patch panels without clip-on.

Description

For a correctly managed installation, Nexans offers a full range of cable management accessories to complement our patch panel and cabinet range. The range is suitable for all Nexans Copper and Optical patch panels.

The new offering is Nexans branded to blend with other Nexans products used in a cabinet.

The cable management range is designed for all 19" cabinets. The range includes patch guides and cable guides.

Patch Guides

The Nexans patch guide range enables orderly patch cord storage. All the Nexans accessories are guaranteed to maintain the required bending radius for patch cords which in turn ensures superior data transmission for the installation. The paint finished metal accessories provide improved stability over plastic guides on the market.

The 1HU and 2HU universal patch guides are delivered with a front plate. The 8 cm depth provides for the bending radius and enough storage space for the patch cords. Two openings designed at the rear face improve the storage and entry possibilities for patch cords.

An alternative 1 HU 5- ring metal patch guide is offered. This accessory similarly allows for orderly patch cord management in any installation.

Cable Guide

The Nexans cable guide offers fast and reliable cable retention and grounding. The clip-on system is a proprietary Nexans design and improves the flexibility, solidity and the grounding of your installation.



Standards

International ISO/IEC 11801

Patch Guides, Blank Panels & Cable Management

Product List

☎ = Make to order, 📦 = Make to stock

Nexans ref.	Name	Colour
☎ N109.207	1HU Blank Panel	White RAL 9002
☎ N109.207BK Nouveauté	1HU Blank Panel, black	Black
☎ N102.105BK	1HU Patch Guide with rings, Black	Black
☎ N102.105	1HU Patch Guide with rings, White	White RAL 9002
☎ N102.117BK	1HU Universal Patch Guide with front cover, Black	Black
☎ N102.117	1HU Universal Patch Guide with front cover, White	White RAL 9002
☎ N102.127BK	2HU Universal Patch Guide, Black	Black
☎ N102.127	2HU Universal Patch Guide, White	White RAL 9002
☎ N521.672 Nouveauté	Angled Blank Panel Black	Black
☎ N521.673 Nouveauté	Angled Panel Cover Black	Black
☎ N521.678 Nouveauté	Angled Pass-Through Black	Black
☎ N424.512	Cable management plate for Essential Rear Connect Panels N424.xxx	Black
☎ N102.115BK	Letterbox Patch Guide 1HU Black	Black

☎ = Make to order, 📦 = Make to stock

Contact

LAN Systems (Nexans Cabling Solutions)
Phone: +44 (0)1256 486640
ncs.uk@nexans.com

LANmark Zone Distribution Boxes

- For use as consolidation point.
- Compatible with all LANmark snap-in connectors.
- 6 or 12 numbered snap-in ports with shutters.
- Easy to install

Description

Designed for use as consolidation points, zone distribution boxes significantly increase the flexibility of desk locations in open office environments. They are particularly useful in offices where frequent relocation of outlets in the work area is required.

Nexans ZD boxes are easy to install on walls, under raised floors or in ceiling voids, due to their multiple mounting features.

They are compatible with all LANmark snap-in connectors, which can be easily inserted by a simple "one-click" movement.



Standards

International ISO/IEC 11801

LANmark Zone Distribution Boxes

Characteristics

Construction characteristics

 Material Steel
Usage characteristics

 Field of application Fixed installations

Product List

☎ = Make to order, 📦 = Make to stock

Nexans ref.	Name	Width (mm)	Colour	Height (mm)	Depth (mm)
📦 N521.600	LANmark ZD box 12 Snap-In White	230	White RAL 9002	45	200
☎ N521.606BK Nouveauté	LANmark ZD box 6 Snap-In Black	120	Black	42	125
📦 N521.606 Nouveauté	LANmark ZD box 6 Snap-In White	120	White RAL 9002	42	125

☎ = Make to order, 📦 = Make to stock

Cabinets - Quick Mount

Cabinets and Enclosures

- 19" cabinet and extension 42 HU 800X800
- flat pack : easy and quick installation
- exclusive automatic earthing system
- security
- complete range of accessories

Description

Features

High Quality Cabinet for installation of Nexans Cabling Solutions Products.

Extremely easy and fast to install and hence very cost effective, thanks to

- Delivery in separate parts which can be handled by only one person
- Fast and flexible mounting within a few minutes
- Open structure which allows a free accessibility from all sides
- Easy to add or remove products after the cabinet has been installed
- Automatic earthing
- IP 20 (can be upgraded to IP 30 by adding an extra roof)
- Possibility to fix on the roof one to 8 individual fan
- Easy to add extensions or to replace panels
- Front and rear frames which can be installed in 3 different positions
- Glass mixed front door
- Only one standard tool required
- No small loose parts
- Secure your installation : front and rear door with eurolock and inside opening system for side panels

Light weight cabinet.

All parts are packed in 6 small boxes which are very easy to manoeuvre.

Several accessories are available for enhanced functionality.

Door in tinted safety glass.







Standards

International ISO/IEC 11801

Cabinets - Quick Mount

Product List

Nexans ref.	Name	Width (mm)	Depth (mm)	Approximate net weight (kg)
 N340.103  Nouveauté	EXTENSION FOR QUICK MOUNT III 42HU 800x800	800	800	145.0
 N340.003  Nouveauté	QUICK MOUNT III 42 HU 800x800	800	800	145.0

☎ = Make to order, 📦 = Make to stock

Cabinets - Wall Mountable

Cabinets and Enclosures

Wall Mountable

- 3 parts 19" wallmount 18HU
- Easy installation

Description

A range of wall mountable cabinets for locations where space is a premium. Includes standard 19" cabinets and empty enclosers suitable for copper or fibre accessories.

Features

- Hinged 3 part design for easy access
- extremely accessible swing frame design. (140mm for back part)
- Top and Bottom cable entry equipped with brushes
- Same functionalities as full size cabinet : 19" mounting frame
- Cable fixing plates on the rear panel for tie wrap
- Hole for up to 3 individual fans on top and bottom
- 60 Kg Load
- Included a 1/1 scale template paper for screw hole preparation before installation
- vertical metal patch guide system on the front for easier handling
- Ideal for locations where space is at the premium
- security with a lock on the door
- tinted safety glass mixed door
- dimensions : 18HUX500mmx650mm





Standards

International
Manufacturer specification

Cabinets - Wall Mountable

Product List

Nexans ref.	Name
 N102.118 Nouveauté	Wall Mount Cabinet 18 HU Mixed Door New Concept

 = Make to order,  = Make to stock

Contact

LAN Systems (Nexans Cabling Solutions)
Phone: +44 (0)1256 486640
ncs.uk@nexans.com

Cabinet Accessories

Cabinet and Enclosure Accessories Range

Complete Range : shelves, spare parts, fans, powerbar,...

Description

Complete range of accessories for 19" cabinets and enclosures

- Spare parts
- Shelf
- Powerbar
- Ventilator Fan
- ...

Standards

International ISO/IEC 11801

Cabinet Accessories

Product List

☎ = Make to order, 📦 = Make to stock

Nexans ref.	Name
☎ N108.109 Remplacé	100 x Caged nut (M6) + screw (M6*12)
☎ N108.109BK Nouveauté	100 x Caged nut (M6) + screw (M6*12), black
☎ N203.167	19 inch SHELF FOR 12/18HU CABINET
☎ N303.162	19 inch shelf (36-42HU)(max. 70 kg, 2 fixation points)
☎ N303.163	19" SHELF (MAX. 70 KG) WITH 4 FIX.POINTS
☎ ISCS71003WMP01 Remplacé	1U Blank Panel
☎ N333.165	4 x ADJUSTABLE FEET FOR QUICK-MOUNT
☎ N343.206	8xpatch ring
☎ N203.158	CLOSET DOC.HOLDER
☎ N333.207	DOOR HANDLE FOR REAR PANELS OF Quick Mount
☎ N203.156	NEON LAMP FOR CABINETS
☎ N203.165	Power Bar 19 inch 1 HU 6 UK outlet
☎ N203.160	Power Bar 19 inch 1 HU 6 UTE outlet + autofuse
☎ N203.160A	Power Bar 19 inch 1 HU 6 schuko outlet + autofuse
☎ N303.164	SLIDING SHELF 19 inch pull out 1/3 maximum load of 30 Kg
☎ N101.001	Signal grounding key
☎ N201.171	Ventilator fan (110 V) + Power cable
☎ N203.171	Ventilator fan (230 V) + Power cable
☎ N340.185	additional plinth for quick mount
☎ N343.209	additional roof (IP 30) for quick mount
☎ N343.204	base for quick mount II & III
☎ N343.208	closing plate for quick mount II
☎ N343.102	connection kit for quick mount II & III extension cabinet
☎ N343.201	front door for quick mount II & III
☎ N343.202	rear door for quick mount II
☎ N343.213	rear door for quick mount II & III
☎ N343.205	roof for quick mount II & III
☎ N343.203	side panel for quick mount II & III

☎ = Make to order, 📦 = Make to stock

Contact

LAN Systems (Nexans Cabling Solutions)
Phone: +44 (0)1256 486640
ncs.uk@nexans.com

Miscellaneous Accessories

Description

Nexans have a complete range of accessories and hardware to complete the LAN system such as multicoloured shutters.

**Standards**

International ISO/IEC 11801

Miscellaneous Accessories

Product List

☎ = Make to order, 📦 = Make to stock

Nexans ref.	Name
📦 N420.655	Blank Snap-In filler for unused port, white
📦 N421.701	White shutter for Snap-In structural hardware
☎ N421.701R	Red shutter for Snap-In structural hardware
☎ N421.701B	Blue shutter for Snap-In structural hardware
☎ N421.701G	Green shutter for Snap-In structural hardware
☎ N421.701Y	Yellow shutter for Snap-In structural hardware
☎ N421.701GR	Grey Shutter for Snap-In Structural Hardware
☎ N421.701BK Nouveauté	Black shutter for Snap-In structural hardware
📦 N420.050 Nouveauté	Dust cap for RJ45
☎ N420.655BK Nouveauté	Blank Snap-In filler for unused port, black
📦 N108.111 Nouveauté	Dzus quarter-turn fastener

☎ = Make to order, 📦 = Make to stock

Software, Training, & Services

Adding value to Local Area Networks is about much more than high quality products.

Nexans provide a range of tools and services, either directly or in conjunction with business partners, to provide an unrivalled service & support package to meet the demands of both installers and end users alike.

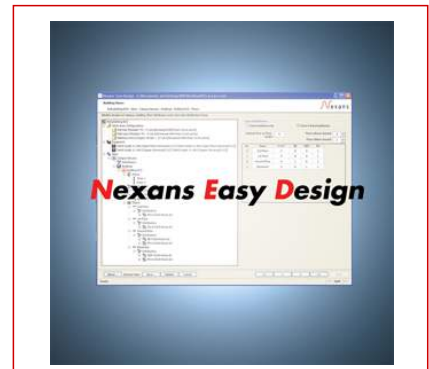

System Warranty Programs

A parts guarantee is one thing. But what happens when you put them together?

Many companies may be specialised in one area but what happens if you have an infrastructure problem between buildings – who is responsible for deciding if it is the copper or fibre campus link at fault.

With a Nexans solution you don't have to worry because we cover the complete cabling system, regardless of transmission medium or the building topology:

- Copper, and Fibre
- Horizontal, Backbone or Campus

Nexans understands different cabling technologies and the building infrastructure, so that's what we cover with the warranty.

Description

A company's communication system is crucial to its industrial and commercial success. Every single day, every company depends on the quality and distribution of information.

With global experience, technological mastery in various building architecture, and a broad portfolio of products, Nexans matches the solution to your needs.

Nexans empowers your local area networking infrastructure to do better and faster business.

Offering Quality of Service to your users and customers is the reference for your success. Quality of Transmission, the performance of your infrastructure, becomes more important and critical.

Our state-of-the-art solutions are your best guarantee for :

- performance
- reliability
- value for money



Standards

International
Manufacturer specification

Network Design Tools

Nexans Visio Templates (NVT) version 3.00 (NEW) is now available for download to enable users to create fast professional cabinet layout drawings and includes new enhanced features.

NVT3 can be freely downloaded and includes now 6 intelligent product libraries (stencils) working under MS Visio to easily create professional Distributor layouts.

Discover our Nexans Easy Design 1.0 software

NED saves time, reduces design and BoM errors.

NED is using a simple intuitive user interface to quickly collect the cabling project data and by using the shapes from the Nexans Visio Template library plus a new NED library it will provide the user with:

- The Building configuration layouts
- The Distributor rack configurations including data about horizontal distribution and cords
- The full and complete Bill of Material of the cabling system

Description







Standards

International
Manufacturer specification

Network Design Tools

Product List

Nexans ref.	Name
 Toolkit	LAN Calculation Toolkit
 NVT	Nexans Visio Template 3.1 with NVT 3D

 = Make to order,  = Make to stock

Training Services

Nexans Cabling Solutions has elaborated its training program.

Training is given at the Competence Centres in Brussels or Basingstoke, or on demand at your premises or in one of our regional Training Centres.

Description

No matter what your level is, we'll find the best training program meeting all of your needs. The LAN technology evolution requires a wide and varied range of skills. No two projects are the same and our partner's position is important in this business. The aim is to find the synergy between your needs and our training program.

In order to make this "level training" program possible, the training has been divided into different modules to address different topics aimed at different people.

- Installers
- Project Managers
- Designers, Consultants and Architects
- Commercial Staff that would like to improve their sales techniques End Users
- Anybody involved in cabling that would like to improve his knowledge and skills in this domain

Trainees can obtain a "Nexans Cabling Solutions Expert level certification" when they succeed in the 3-day Expert training.

It is clear that a new VAR, Distributor, or Certified System Installer will be required to succeed in the Expert training. If the new partner has no experience it is recommended that he will first attend the basic training. If the partner has previous experience, he can directly follow the Expert training.

Training Modules Overview

Commercial:

Module 3: *Nexans Copper Cabling Solutions*

Module 8: *Nexans Optical Fibre Cabling Solutions*

Expert Knowledge:

Module 1: *Premises Cabling Standards*

Module 2: *Parameter for Copper Cabling*

Module 4: *Installation Rules and Guidelines*

Module 7: *Optical Fibre Theory and Principles*

Module 12: *Design Training: Project Study*

Module 14: *Design Training: Project Engineering*

Module 16: *Project Management*

Hands-on:

Module 5: *Installation Practice & Testing Class D-E Links*

Module 6: *Installation Practice & Testing Class F Links*

Module 9: *Fibre Installation Practice with Direct Termination*

Module 10: *Fibre Installation Practice on Fusion Splicing*

Module 11: *Testing Optical Fibre Links*

Module 13: *Nexans Easy Design Visio Software*



Standards

International
Manufacturer specification

LANmark-6A



10G

LANMARK-6A - OPTIMISE SHORT LINKS

80% of Data Centres will implement 10G in the coming years. Exceeding Category 6A standards, LANmark-6A enables short link support avoiding space

problems by overlength cables. Screened technology eliminates alien crosstalk ensuring easy installation and on-site testing. LANmark-6A: Zero Risk 10G

 **Nexans**

Global expert in cables
and cabling systems



Global expert in cables and cabling systems